

10. Discussion of lease ballot measure for voter approval of Adventist Health lease of real property and sale of assets of Tulare Local Healthcare District.

Tulare Local Healthcare District dba Tulare Regional Medical Center

Agenda Item

Board Meeting Date: 07-17-18

Title to Appear on Agenda: Air Cooled Chiller, Steam Generator, Vacuum pumps, Circulating Chill Water Pumps, Medical Air Pump

Brief Description: Multiple Utilities are not functioning and need to be replaced which assist with various components of the facility with day to day functions.

Background and Details: One of the Chillers (70 ton) has seized and is no longer operational as of last year. This aids, along with the other 70 ton chiller, to supply cooled air to the 1950's side of the facility. Currently the one operational chiller dedicated to the 1950's cannot keep up with the current demand. The chiller works to maintain an optimal temperature and humidity level throughout the facility. Temperature and humidity are mandated to be within a specific range by Title 22. Due to the time constraints to reopen the facility, OSHPD process for Chiller installation and the necessity to have optimal operational temperatures, a temporary Chiller will be required to be put in place prior to opening until the permanent Chiller is completely built to specification and installed. Also, one of the steam generators in the penthouse which works to serve sterile processing and OR steam sterilizers, is not operational. The demand on the current one is far greater than can be handled and slows the sterilization process down. Appropriate steam levels are necessary for proper sterilization of instruments used for specific procedures. Vacuum pumps (2) which serve the 1950's building are not operational. Both Vacuum pumps have seized and need to be replaced.

They serve for needed vacuum during multiple types of procedures and treatment regimens. Circulating chill water pumps are very aged and have seized. They work along with the chiller to circulate water to maintain an appropriate temperature within the facility. Medical Air pump (2) work to entrain air used and or needed for specific treatment regimens and or therapy. One of the pumps has seized and needs to be replaced.

All of the items listed are specific to life safety, NFPA 99 and or Title 22. The repairs will require OSHPD approval.

Bids obtained and attached

Air Cooled Chiller-\$78,000 one-time charge plus \$10,500 per month. This will be temporary until the permanent chiller is put in place. Additional dollars on permanent chiller unknown at this time.

Provide a complete structural, mechanical and electrical engineering plan to insert a long term temporary chiller, steam generator replacement, vacuum pumps, chilled water pumps and medical air compressors replacement/relocation.-\$82,000

NOTE: Cost associated with all items listed above are not reflected in the actual purchase of equipment. Cost on equipment shall be supplied post design. Other costs may incurred dependent upon scope of work, unknowing issues.

Exhibits: See attached

Recommended Action: Hospital Board approve New England Sheet Metal and Mechanical Co. to proceed with proposed scope of work delineated in proposals.



2731 S. Cherry Ave
Fresno, CA 93706
(559) 268-7375
www.nesm.com

July 12, 2018

Owner: Tulare Regional Hospital
Subject: Rental chiller install
Location: 869 N Cherry St. Tulare, CA 93274

Mr. Blitz,

We are proposing to provide a temporary 155 ton air cooled chiller to be tied into the existing chilled water header in the central plant. This will provide you the cooling capacity until we can install the new permeant chiller that will fit your needs moving forward. Attached you will find our plan for execution/ location of this temporary chiller and how it fits into your facility.

SCOPE:

- Provide and install (1) one 155 Ton Air Cooled chiller located on a flatbed trailer/on the ground outside the main hospital, we will be taking up 3 parking spaces.
- Provide CAD drawings for your approval, That will designate correct TIE-IN locations for electrical and water
- Install (1) one 600 Amp breaker and subpanel located inside electrical room
- Provide and install temporary electrical leads needed for above mentioned project
- Provide and install Supply/ Return water hose to accommodate the 155 ton chillers flow rates.
- Connect supply/return water piping at the existing header for the central plant.
- Provide water balance to fit the temporary chiller into the existing loop
- Provide owner training and startup of the equipment

Exclusions: Anything that is not stated in the scope of work

Pricing:

- Reoccurring monthly cost:
 - Chiller rental: \$10,500.00 per month
- Initial set up cost - NESM (one-time expense)
 - Deliver & pick up chiller
 - Install and remove temporary chilled water supply & return piping (PVC) from the chiller to the existing connection taps inside the chiller room
 - Temporary electrical sub panel in basement
 - Start up chiller
 - Water balance
- **TOTAL ONE-TIME EXPENSE (ROM): \$78,000.00**

Please contact me if you have any questions.

Corporate Office: P.O. Box 4287, Fresno, CA 93744

Exclusions:

- Patching or painting of any kind
- Overtime after hour labor or weekend labor
- Roofing of any kind, repair or replacement of roof system
- Framing of any kind, including framing to support roof curbs and duct penetrations
- Duct sealing, repair or replacement other than that specifically mentioned above
- Plan check fees
- Structural modifications or any pre-existing mechanical, electrical, gas, or condensate issues not discovered in the initial survey.

Additional Conditions

- All pre-existing conditions are considered extra
- No work will be scheduled until all proper documentation is received by this office (i.e. credit approval, signed contract)
- The first month rent and 75% of the one-time fee will be billed upon startup of the rental chiller

Best Regards,

Matt Grabowski
Service Sales Manager
Mgrabowski@nesm.com
(559) 779-5814

Acceptance

Print Name _____

Title _____

Signature _____

Date _____

Exhibit A: General Terms and Conditions

1. New England Sheet Metal and Mechanical Co. reserves the right to request and receive financial data to support the Contractor's and Owner's ability to make timely payments for our work and will not start our scope of work until we have received evidence, to our satisfaction, that there are sufficient funds set aside to pay for the work performed by New England Sheet Metal and Mechanical Co.
2. New England Sheet Metal and Mechanical Co. reserves the right to suggest and make contractual changes to any future contract or subcontract documents. New England Sheet Metal and Mechanical Co. has the right to a copy of all contract documents between the Owner and Contractor that may affect our work.
3. This proposal includes costs for insurance policies: General Liability (2 million/4 million) and Automotive (1 million) with additional insured as requested along with standard Worker's Compensation (1 million) coverage. Builder's risk insurance coverage (All Perils/Earthquake/Flood, etc.) for our scope of work is not included. New England Sheet Metal and Mechanical Co. shall be named as additional insured on the Contractor's policy with maximum deductible losses for New England Sheet Metal and Mechanical Co. at an aggregate of \$5,000. Additional coverage or any payment of deductibles may be at an extra cost.
4. The duty to indemnify shall not extend to the acts of willful misconduct or sole negligence, active or passive, on the part of the Contractor, Owner or anyone associated with them.
5. Parties shall make efforts to resolve disputes through utilization of a mutually agreed upon Dispute Resolution Process prior to pursuing a court action. Should either party to this agreement bring suit in court to enforce the terms of this agreement, any judgment awarded shall include court costs and reasonable attorney's fees to the successful party.
6. Monthly payments are as agreed to in the executed contractual documents or as follows; Payment for services rendered by the 15th of each month for 100% of all work performed during the preceding month. Final payment to be made within 30 days after completion and acceptance of our scope of work. Late payments shall incur an interest charged by law along with prompt payment penalties, or at a minimum rate of eighteen percent (18%) per annum on past-due accounts.
7. No contractual obligations shall limit the Contractor's responsibility for safety and a safe place to work under applicable laws and regulations, or require New England Sheet Metal and Mechanical Co. to assume Contractor's responsibilities.
8. New England Sheet Metal and Mechanical Co. shall be equitably compensated for additional verified costs it incurs as a result of delays (or accelerations) caused by the acts or omissions of the Owner, Contractor, or its other Subcontractors or the Suppliers to any of them. New England Sheet Metal and Mechanical Co. shall not be assessed damages during any delay in the completion of the work caused by acts of God, acts of the public enemy, acts of Owner, Owner's agents, the State Of California, Local County, Local City, any applicable utility district, any railroad, acts of other public utilities, strikes and unusually severe weather conditions which preclude performance of the work; delays resulting from war or national or local emergencies; or delays of New England Sheet Metal and Mechanical Co.'s suppliers due to such caused, or the owner of a utility to provide for removal or relocation of utilities.
9. If hazardous or similarly classified material or a change in site/project conditions is encountered, New England Sheet Metal and Mechanical Co. will cease all operations and the Contractor and/or Owner will determine the nature and extent of such conditions, and will recommend the nature and extent of remediation. Any hazardous or a change in site/project conditions that are encountered shall be considered as extra work for New England Sheet Metal and Mechanical Co. regardless of payment for such work made to Contractor by Owner.
10. If unsuitable ground conditions are encountered, Owner will determine the nature and extent of such soil conditions and will recommend the extent of remediation. Yielding sub soil, over optimum moisture, hazardous material, and rock (unable to be excavated with a Caterpillar 446 Backhoe) shall be defined as unsuitable ground conditions. Unsuitable ground conditions shall be considered as extra work to New England Sheet Metal and Mechanical Co.
11. All contractual correspondence and payments shall be directed to our Corporate Office at P.O. Box 4287, Fresno, CA 93744-4377 (Overnight: 1210 W. Olive Avenue, Fresno, CA 93728).
12. "Contractors are required by law to be licensed and regulated by the Contractors State License Board. Any questions concerning a contractor may be referred to the Register of the board, whose address is: Contractors State License Board, 9835 Goethe Road, P.O. Box 26000, Sacramento, California 95826." New England Sheet Metal and Mechanical Co.'s California Contractor's License No.: 433674.



2731 S. Cherry Ave
Fresno, CA 93706
(559) 268-7375
www.nesm.com

PROJECT DEVELOPMENT AGREEMENT (PDA)

This Agreement is made this 12th day of July in the year 2018, by and between the

OWNER

Tulare Regional hospital-Larry Blitz
869 N Cherry St.
Tulare, CA 93274

and the

DESIGN-BUILDER

New England Sheet Metal and Mechanical Co.
2731 S. Cherry Ave.
Fresno, CA 93706

for the

PROJECT

Provide a complete structural, mechanical and electrical engineering plan to insert a long term temporary chiller, steam generator replacement, vacuum pumps, chilled water pumps and medical air compressors replacement/relocation.-

1.0 General Provisions

The Design-Builder is hereby authorized to proceed with the necessary development services as outlined below. Work under this Agreement should commence immediately and be completed under the consultation with the Owner in a manner intended to facilitate effective and efficient development of the project. No other work is authorized without written permission from the Owner. Upon completion of this Agreement a formal contract for design-build services will be forwarded for signature in accordance with Section 10 below.

1.1 Team Relationship

The Owner and Design-Builder agree to work together on the basis of trust, good faith and fair dealing, and shall take actions reasonably necessary to enable each other to perform their obligations under this Agreement in a timely, efficient and economical manner.

1.2 Confidentiality

The Owner and Design-Builder shall treat as confidential and not disclose to any third parties, except as is necessary for the performance of the Services, or use for its own benefit, any of the Owner's, Owner's Consultants', Design-Builder's, or Design-Builder's Subcontractor's developments, confidential information,

Corporate Office: P.O. Box 4287, Fresno, CA 93744

know-how, estimating systems, historical and parameter cost data, discoveries, production methods and the like that may be disclosed to one another or that may be acquired in connection with the Services or the performance of this Agreement.

2.0 Design-Builder's Responsibilities

2.1 Project Development Services

The Design-Builder's Services are indicated below. As applicable, the Design-Builder shall coordinate its services with all services of other consultants and subcontractors that may be retained by the Owner. The Design-Builder shall identify in writing any material changes and/or deviations, if any, that it makes to any of the deliverables described below after it first delivers the same to the Owner. These services shall be performed in accordance with the schedule established by the Design-Builder.

2.2 Scope of Services

- Perform an engineering-based study to determine best options for piping/ electrical routing.
- Coordinate structural anchorage, mechanical and electrical requirements for the new temp chiller, steam generator, vacuum pumps, chilled water pumps and medical air compressors design.
- Coordinate with the Electrical Engineer for completion of this design package.
- Present the design concept to the Hospital for approval.
- Develop a construction cost proposal for the project design. The design fees presented in this proposal will be included in the project costs, presented at the completion of design. If the owner moves ahead into construction, the design costs will be part of the construction costs and will not require a separate payment. If the project does not move into construction by New England Sheet Metal and Mechanical, the fees will be due and payable. The plans prepared and approved will not be available for use by the owner.
- Prepare a Structural anchorage, Mechanical systems and Electrical systems design for the long term temporary chiller, steam generator, vacuum pumps, chilled water pumps, medical air compressors and present to OSHPD for review and approval.
- Include structural anchorage, mechanical and electrical plan revisions as required to gain OSHPD approval.

Exclusions:

- OSHPD fees.
- IOR, Inspection and Testing Fees.
- Architectural fees and changes

2.3 Schedule

The Scope of Services outlined in Scope of services, above will take approximately 4 to 6 weeks to complete the rental chiller after execution of this agreement and an additional 6 weeks for the medical air, vacuum pumps and steam generator design

2.4 Hazardous Material

If hazardous, or similarly classified, material is encountered and affects the investigative process, Design-Builder shall suspend development operations as necessary and provide observations to the Owner so that the Owner can determine the nature and extent of such conditions. This will be considered extra work for the Design-Builder. There is known asbestos in the work area, so this must be remediated by the owner, at the owner's expense prior to any work commencing.

2.5 Design-Builder's Authorized Representative

The Design-Builder's representatives are **Dennis Enns, Matt Grabowski and Mike Hensley**

3.0 Owner's Responsibilities

3.1 Project Development Support Services

The Owner shall provide the Design-Builder with such decisions and information related to the Project as may be requested from time to time.

3.2 Owner's Authorized Representative

The Owner's representative is _____

4.0 Compensation

For the scope of services provided under this Agreement, the Owner shall compensate the Design-Builder by paying in full any submitted monthly invoices. The amount of Design-Builder compensated services under this agreement shall be:

Eighty Two Thousand Dollars \$82,000.00

4.1 Design-Builder's Invoice and Owner's Payment

The Parties agree that the Owner's payment of the Design-Builder's invoice is not tied to or dependent on the Owner receiving payment (partial or full) from any third party or finalization of any claim with a third party. The payment for any and all services rendered by the Design-Builder is immediately due based upon the terms contained herein with no other agreement or interpretation otherwise. On or about the first day of each month after the execution hereof, Design-Builder shall submit a Design-Builder's Invoice to Owner for the services rendered under this Agreement through the end of the Prior Month. Upon Owner review for five (5) calendar days, all payments shall be due net fifteen (15) calendar days thereafter. Overdue payment obligations shall bear interest from the date due until the date paid at a rate per annum equal to the Wall Street Journal Prime Rate in effect from time to time plus four percent (4%).

5.0 Termination

This Agreement shall continue until **Oct 1, 2018** unless earlier terminated by either the Design-Builder or Owner by reason of the Project's infeasibility with written notice to either party. Any amounts owed will be promptly paid by Owner to Design-Builder.

6.0 Governing Law

California law shall govern this Agreement.

7.0 Future Design-Build Agreement

This agreement is intended to be used as a preliminary step in developing a Contract between the Owner and the Design-Builder for design and construction of the Project. Upon execution of this Project Development Agreement, the Owner and Design-Builder agree to enter into good-faith contract negotiations for future Design-Build Services.

7.1 Work Product

Any use of the Work Product is at the Owner's sole risk without liability or legal exposure to Design-Builder or anyone working by or through the Design-Builder (all those collectively known as "Indemnified Parties"). Owner shall defend and hold harmless the Indemnified Parties from any and all claims, damages, liabilities, loss and expenses, including attorneys' fees, arising out of or from the use of the Work Product.

8.0 Exclusive Relationship

During the term of this Agreement, neither the Design-Builder nor Owner shall enter into, negotiate toward, or take any other action in furtherance of entering into, or assisting another to enter into, any agreement for provision of the services or equipment to be provided by any party listed herein.

This Agreement is entered into by the authorized individuals for the California Corporations listed below.

OWNER:

Tulare Regional Hospital

BY: _____

PRINT NAME: _____

PRINT TITLE: _____

DESIGN-BUILDER:

NEW ENGLAND SHEET METAL AND MECHANICAL CO.

BY: _____

PRINT NAME: _____

PRINT TITLE: _____

Patton Build. Trust.

272 N. Palm Ave.
Fresno, CA 9370
(559) 486-5222
FAX 486-5596

<http://www.pattonac.com>
Lic. No. 256026

Date: 7/16/2018

SITE: Tulare Regional Hospital
RE: New Air-Cooled Chiller Installation
ATTN: George Canto

Patton is pleased to provide the following proposal for the installation of a new 140ton air-cooled chiller located outside on the ground level of the Tulare Regional Hospital. The following items are included in the base bid portion of this proposal.

BID INCLUSIONS:

- Provision and installation of a new 140ton, Daikin air-cooled scroll compressor chiller with required OSHPD OSP certification
- Provision and installation of two (2ea) new chilled water pumps, 15hp Armstrong end suction and associated variable frequency drive
- Provision and installation of all 4" sch40 carbon steel supply and return chilled water piping and required mounting hardware, stands and supports between the new chiller on ground level and the existing points of connection in the mechanical room located in the below ground level
- Insulation of all new chilled water supply and return piping and pumps with aluminum metal jacketing in weather exposed areas and ADP paper in unexposed areas
- Provision and installation of a new thermal expansion tank, backflow preventer and associated pipe and fittings for makeup water connections
- New 26'Lx16"Wx12"H concrete equipment pad below new chiller located in the owner specified location of the parking lot. Includes all site preparation of dirt soil prior to Rebar and concrete installation
- All required saw cutting of existing asphalt at new chiller pad location as well as any required excavation/haul away of unused soil and debris
- New 26'Lx16"Wx6'H chain link fence with one large double swing access gate and one single entry gate
- Electrical power supply required for the new chiller and pumps from the existing main breaker in the north side mechanical yard. Power will be routed from existing panel, below grade, in conduit to the new air-cooled chiller. All saw cutting, demo, excavation, backfill and patch back of the existing parking lot is included where at the new below grade conduit path only.
- Low voltage control wiring between new chiller and pumps & VFD's in watertight conduit is included
- All required USA and/or site utility investigation is included in this proposal and will be executed prior to any excavation
- **If performance and payment bond are required, please add 1.44% to the total project cost**
- All project management and coordination with other trades to ensure a turn-key project is provided
- All OSHPD documentation, drawings, engineering and associated fees are included in this proposal

*****Clarifications:**

- Prior to ordering of the new chiller and associated equipment, Patton will require a deposit of 30% of the total contract amount.
- A progress payment of 60% is required upon completed chiller installation and prior to start-up of the new chiller and pump
- After completion of start-up and the final OSHPD inspection the remaining 10% of the total contract amount is due
- Anticipated lead time of new chiller is 8-10 week and must be taken into consideration with acceptance of this proposal

Exclusions:

- No construction schedule provided during bid time.
- Liquidated damages have not been discussed prior to the bidding phase of this project
- Complete refinishing of the existing asphalt parking lot is not included in this proposal. Patch back of the opened areas only are figured
- Overtime, after hour and/or holiday work of any kind is excluded in this proposal. Normal working hours are figured
- Modifications to existing curbs, sidewalks and or drainage gutters
- Provision and installation of chain link fence slats are not included
- Exterior stucco finish and/or painting of the exterior finish
- Anything not specifically called out in the inclusions above
- Performance and payment bond is NOT included in this proposal (Please add 1.44% to total amount below if required)
- Abatement of any existing asbestos is not included in this proposal (by owner if required)
- Inspection costs are not included in this proposal (by owner)
- Permit fees are not included (by owner)

Total cost for the above-mentioned work = \$492,977.00

ADDITIVE ALTERNATE

- Same as above, but with larger capacity chiller (200ton) for added capacity for future. Modified utilities required for larger capacity chiller as necessary

- ADD to the above cost = \$44,501.00

If you have any questions or concerns, please contact Scott Likins or Austin Lopez in the office at any time.

Austin Lopez
Project Manager/Estimator
Patton Air Conditioning
272 N. Palm Ave.
Fresno, CA 93701-1436
License #256026
Phone (559) 486-5222
Cell (559) 408-4127
Email: alopez@pattonac.com
Website: www.pattonac.com

Lionel Machado

From: Rod Galvan <rgalvan@emcor.net>
Sent: Tuesday, June 05, 2018 4:13 PM
To: Lionel Machado
Cc: Sandra Gomez
Subject: Re: Chiller Replacement quote

Sorry, yes. My engineering department says that since this Project needs to be OSHPD that I cannot provide pricing without some drawing that are OSHPD approved. Therefore the drawings need to be done first.

With that said it could run around 40-50k for Engineering?

Once we can get drawings done then putting a price to them is no problem. I can't feel comfortable pricing against something I don't know. I hope you can understand that.

We want to help out but the unknown OSHPD factor can hurt us all.

Thanks,

Rod Galvan
Sales Manager - Central California
EMCOR Services/Mesa Energy Systems, Inc
559-213-8845

On Jun 5, 2018, at 4:00 PM, Lionel Machado <lmachado@tulareregional.org> wrote:

BE ADVISED - This email originated outside EMCOR.

Rod, do you have an update on the chiller replacement quote? I really need to get some feedback on this as soon as possible.

Thanks,

Lionel Machado RCP, RRT
Director Respiratory Care Services/Facilities
Safety Officer
EOC/Emergency Preparedness Coordinator
Security
Tel: (559)685-3468 Ext. 3480 Facilities or (559)366-1123 ext. 1123 Respiratory | 869 N. Cherry Street,
Tulare, CA 93274
lmachado@tulareregional.org

This message is for the named person's use only. It may contain confidential, proprietary or legally privileged information. No confidentiality or privilege is waived or lost by any mistransmission. If you receive this message in error, please immediately delete it and all copies of it from your system, destroy any hard copies of it and notify the sender. You must not, directly or indirectly, use, disclose, distribute, print, or copy any part of this message if you are not the intended recipient.

Proposal for:

AIR COOLED RENTAL CHILLER

Presented to:

Lionel Machado
TULARE REGIONAL MEDICAL CENTER

Prepared by:



Rod Galvan
EMCOR Service / Mesa Energy Systems, Inc.
4668 N. Sonora Ave. Suite 102
Fresno, CA 93722

Date: April 24, 2018
Proposal # 02710
Valid for 30 Days



4668 N SONORA AVE SUITE 102 • FRESNO, CA 93722 • (559) 277-7900 • FAX (559) 277-4920
CCL # 611215

April 24, 2018

TULARE REGIONAL MEDICAL CENTER

Mr. Lionel Machado
869 N Cherry St.
Tulare, Ca 93274

RE: Air Cooled Rental Chiller

Dear Lionel,

EMCOR Service / Mesa Energy Systems, Inc. is pleased to submit our proposal for the Air Cooled Rental Chiller as you requested.

Included in the pricing we would provide the labor, materials, equipment and the necessary materials to complete the following:

Scope of Work

- Install (1) 100 Ton Air Cooled Chiller on a trailer.
- Install Support Equipment and piping to existing connections in Basement.
- Provide Temporary power from existing Panel in Electrical Yard (as was done before) and set temporary poles in parking lot.
- Perform start-up and testing.
- Upon completion of rental will remove all temporary power and water connections for the chiller and have unit removed.

NOTES:

- All rates & values are in USA Dollars only.
- A surcharge will be applied for "after hours" shipments (Evenings, weekends, holidays...).
- Rates are based upon listed rental period. Shorter duration are more costly on a monthly or weekly basis.
- Rental begins the day equipment departs depot & ends when equipment return.
- "Trailer Mounted" equipment is not to be unloaded, unless otherwise noted.
- Labor associated with the equipment leveling is not included in this proposal.
- Customer's responsibility to call Emcor Services for equipment removal & subsequent end of the rental commitment.



4668 N SONORA AVE SUITE 102 • FRESNO, CA 93722 • (559) 277-7900 • FAX (559) 277-4920
CCL #611215

CUSTOMERS RESPONSIBILITIES

- Compliance with all local codes and any necessary permits and licenses.
- Payment of any applicable taxes, if tax exempt, a copy of the exemption certificate is required.
- Maintenance of equipment during the project term.
- Decontamination or cleaning of any hazardous chemicals or fluids.
- Insure the rental equipments security up to its full replacement value , regarding theft, vandalism & "acts of God"
- Return all rental equipment & materials in 'good working order.' (Customer billed for all damaged / lost items.)

BILLING POLICY & PAYMENT TERMS

Billing policy is based on a 4-week monthly/28 days equal one month. Terms are now 30 days from date of invoice. Mesa Energy Systems, Inc. Terms and Conditions apply. Additional weeks invoiced at 1/3 of the monthly rental rate, and additional months at the previously specified monthly rate. We look forward to working with you until the successful completion of this project. If you have additional questions or require additional information, please do not hesitate to contact us.

EXCLUSIONS:

- Overtime and off-hour labor premium.
- Fuel provision, (can be provided at an additional cost).
- Seismic or structural engineering.
- Hazardous material handling or testing or anything other than stated above.



4668 N SONORA AVE SUITE 102 • FRESNO, CA 93722 • (559) 277-7900 • FAX (559) 277-4920
CCL #611215

PRICING

Freight In.....	\$ 587.54
Freight Out.....	\$ 587.54
Setup of Rental.....	\$ 1,855.72
Teardown of Rental.....	\$ 1,855.72
Monthly Rental Fee (28 DAYS).....	\$12,643.00
Rigid Piping from Rental location to Basement piping connections.....	\$30,792.00
Temporary Power Installation/Removal.....	\$17,908.00

Pre-Payment of \$127,001.26 is due in advance before we can Mobilize any equipment and consists of the following:

****6 months of Rental (75,858.00), Freight In (587.54), Set-up (1,855.72), Rigid PVC Piping (30,792.00) and the Temporary Power (17,908.00) is due in advance before we can mobilize any equipment to site.**

Please feel free to contact me with any questions or if you need any additional clarification at (559) 213-8845, if you would like for us to proceed with the above, please sign and date where shown below and return a copy to our office and we will get this work scheduled in coordination with you as soon as possible. Our fax number is (559) 277-4920.

I look forward to hearing from you and thank you for the opportunity to be of service to you and your organization.

Sincerely,
EMCOR Service / Mesa Energy Systems

Rod Galvan
Sales Manager Central California

Acceptance: **TULARE REGIONAL MED CENTER**

Signature _____

Printed Name _____

Title _____

Date _____



4668 N SONORA AVE SUITE 102 • FRESNO, CA 93722 • (559) 277-7900 • FAX (559) 277-4920
CCL# 611215

Terms and Conditions:

- A. Unless stated otherwise in this agreement, services provided under this agreement will be performed during normal working hours of 7 a.m. to 5 p.m., Monday through Friday.
- B. The guarantees and services provided under the scope of this agreement are conditioned upon **TULARE REGIONAL MEDICAL CENTER** operating and maintaining systems/equipment. **TULARE REGIONAL MEDICAL CENTER** will do so in accordance to industry-accepted practices, or in consideration of our recommendations.
- C. **TULARE REGIONAL MEDICAL CENTER** will provide and permit reasonable access to all areas where work is to be performed. EMCOR Service will be allowed to start and stop equipment as necessary to perform its services and be permitted use of existing facilities and building services.
- D. Any repairs or services resulting from power failures, freezing, roof leaks through curbs or equipment, or air side corrosion will be paid for by the **TULARE REGIONAL MEDICAL CENTER** in accordance with EMCOR Service's currently established rates.
- E. The agreement does not include responsibility for system design deficiencies, such as, but not limited to poor air distribution, water flow imbalances, system equipment and component obsolescence, electrical failures, unserviceable equipment, and operating the system(s), unless otherwise stated in this Agreement.
- F. EMCOR Service will not be liable for delays or failure to obligate due to fire, flood, strike, lockout, freezing, unavailability of material, riots, acts of god, or any cause beyond reasonable control.
- G. EMCOR Service is not responsible for the removal or disposal of any hazardous materials or any cost associated with these materials unless otherwise noted in this Agreement.
- H. The agreement does not include repairing any damage resulting from improper/inadequate water treatment or filter service not supplied by EMCOR Service.
- I. This agreement does not include any services occasioned by improper operation, negligence, vandalism, or alterations, modifications, abuse, or misuse, or repairs to equipment not performed by *EMCOR Service*. Unless otherwise agreed, also excluded is the furnishing of materials and supplies for painting or refurbishing existing equipment.
- J. EMCOR Service shall not be required to furnish any items of equipment, labor, or make special tests recommended or required by insurance companies, Federal State Municipal or other authorities except as otherwise included in this Agreement.
- K. In the event either party must commence a legal action in order to enforce any rights under this contract, the successful party shall be entitled to all court costs and reasonable attorney's fees as determined by the court for prosecuting and defending the claim, as the case may be.
- L. EMCOR Service shall not be liable for the operation of the equipment nor for injuries to persons or damage to property, except those directly due to the negligent acts or omissions of its employees and in no event shall it be liable for consequential or speculative damages. It shall not be liable for expense incurred in removing, replacing or refinishing any part of the building structure necessary to the execution of this Agreement. It shall not be held liable for any loss by reason of strikes or labor troubles affecting its employees who perform the service called for herein, delays in transportation, delays caused by priority or preference rating, or orders or regulations established by any government, authority, or by unusual delays in procuring supplies or for any other cause beyond its reasonable control.
- M. Only EMCOR Service's personnel or agent are authorized to perform the work included in the scope of this agreement. EMCOR Service may, at its option, cancel or waive its obligations under this Agreement should non-authorized individuals perform such work.
- N. This Agreement and all rights hereunder shall not be assignable unless approved by EMCOR Service. In the event of additional freight, labor, or material costs resulting from **TULARE REGIONAL MEDICAL CENTER** request to avoid delays with respect to equipment warranties, or accelerated delivery of parts and supplies, **TULARE REGIONAL MEDICAL CENTER** agrees to pay these additional costs at EMCOR Service's currently established rates.
- O. EMCOR Service's scope of work shall not include the identification, detection, abatement, encapsulation or removal of asbestos or products or materials containing asbestos or similar hazardous substances. In the event EMCOR Service encounters such material in performing its work, EMCOR Service will have the right to discontinue work and remove its employees until the hazard is corrected or its determined no hazard exists.
- P. This Agreement contains the entire Contract and the parties hereby agree that this Agreement has been agreed to and the entire Agreement is then accepted and approved by an authorized person for both parties, and no statement, remark, agreement or, understanding, oral or written, not contained herein, will be recognized or enforced.
- Q. This agreement does not include the disposal of hazardous waste; any charges incurred for their proper disposal will be born by **TULARE REGIONAL MEDICAL CENTER** as an extra to the contract price.
- R. **TULARE REGIONAL MEDICAL CENTER** agrees that in the event that there shall have been passed a federal and/or state law which shall compel EMCOR Service to contribute to a federal and/or state health plan for its employees, then the terms of this Agreement shall be subject to adjustment to the extent that the cost of such mandated contributions increase by EMCOR Service's cost of performing this contract.
- S. **TULARE REGIONAL MEDICAL CENTER** acknowledges and agrees that any purchase order issued by **TULARE REGIONAL MEDICAL CENTER** in accordance with this Agreement, is intended only to establish payment authority for **TULARE REGIONAL MEDICAL CENTER** internal accounting purposes. No purchase order shall be considered to be a counteroffer, amendment, modification, or other revision to the terms of this agreement. No term or condition included in the **TULARE REGIONAL MEDICAL CENTER** purchase order will have any force or effect.

Tulare Local Healthcare District dba Tulare Regional Medical Center

Agenda Item

Board Meeting Date: 07-17-18

Title to Appear on Agenda: Asbestos abatement for MS 2 med room floor mastic, OR wall tiles mastic, 2nd Floor hallways floor mastic.

Brief Description: Due to the age of the flooring and tile, the mastic was tested for Asbestos. Asbestos was noted in areas specific to MS 2 med room flooring mastic, OR wall tile mastic and 2nd Floor hallways mastic.

Background and Details: Carpet flooring needs to be removed on 2nd Floor hallway and OB hallways because of infection controls risks. Likewise, the OR rooms in all 3 OR rooms have broken or missing tiles that need to be replaced. VCT tile in Med Surg 2 has multiple tiles that are also cracked/broken. These are items that are either an infection control risk and or a safety issue. Due to the age of the facility, environmental testing was conducted to ensure safety and also to expedite flooring without possible delays.

Bids obtained and are attached.

2nd Floor Corridors- \$22,716

OR Rooms-\$3,817

MS 2 Med Room-\$2,084

Exhibits: See attached

Recommended Action: Hospital Board approve Parc Environmental to proceed with proposed scope of work delineated in proposals.

with OA



ENVIRONMENTAL

Solutions Made Easy

CA Lic. #501913 NV Lic. #0034638 DOSH Registration #19 Hauler Registration #2908 EPA #CAR000263707

24 Hour Emergency Spill Response • Asbestos Abatement • Lead Paint Removal • Hazardous Waste Hauling & Disposal
Soil Remediation • Site Assessments • Microbial Decontamination • Indoor Air Quality • Lab Packing • Hydroblasting

PROPOSAL

NO: 98-177R2

TO: Tulare Regional Medical Center

DATE: 6/28/18

ATTN: Sandra Gomez

PHONE: 559-685-3477

E-Mail: sgomez@tulareregional.org

JOB NAME: Asbestos Carpet/Glue Corridor Project – Tulare Regional Medical Center

PARC Environmental, hereinafter designated as PARC, proposes to perform the following Scope of work:

Scope of work:

Remove, transport, and dispose of Asbestos Containing Carpet Glue.

Price is based on the following:

1. Setup critical barriers, negative air pressure and containment in the Corridor.
2. Remove Baseboards, Carpet and Mastic in the corridor.
3. Carpet Glue to be removed with chemicals and buffers.
4. Dispose materials as Hazardous Waste with a signed manifest.
5. Power and water to be supplied to PARC at no additional cost.
6. Work to be done in one mobilization.
7. Work to be done during normal business hours.
8. Price includes all applicable APCD (\$960) fees and notifications.
9. Price is based on Non-Prevailing Wage Rates.

COST: \$23,627.00

- ✓ This proposal shall be incorporated into any contract and attached to it as an Exhibit.
- ✓ Retention shall be paid within 90 days of substantial completion of work by PARC.
- ✓ Unless otherwise noted, this is a lump sum proposal; quantities listed are informational only and not to be used for deductive pricing. Unless otherwise noted, price is based on non-prevailing wages.

PROPOSAL TERMS: All work shall be performed in accordance with state and federal regulations pertaining to abatement of hazardous materials including transportation and disposal of waste. PARC carries liability, worker's compensation, and auto insurance. Unless otherwise stated; the customer agrees to supply sufficient water and electricity at no cost to PARC; the customer acknowledges that abatement requires the application of tape and agrees that PARC will not be held responsible for tape damage or for repainting; this bid is based on performing the work during regular work hours; PARC shall not be responsible for weather protection or for damages resulting from weather or vandalism; this proposal is subject to change and may be withdrawn if not accepted within 30 days of the above date.

TRANSPORTATION OF WASTE TERMS: The Generator authorizes PARC Environmental to sign all transportation documents and waste profiles as "agent for the generator". PARC will forward all required documentation to Generator. PARC Environmental will abide by all local, state, and federal regulations when handling, packaging, and transporting all wastes.

PAYMENT TERMS: Cash forthwith for any portion of work commenced and completed in any one calendar month. Balance of contract price due and payable within 10 calendar days upon completion of PARC's work. Unpaid monies shall be subject to a finance charge of 1.5% per month. The customer agrees to compensate PARC for any collection related costs, including reasonable attorney fees, if full payment is not timely made to PARC. The customer agrees that the court of jurisdiction, for any claim, shall be located in Fresno County.

Accepted _____, 2018

PARC Environmental

By: _____

Approved:

Title: _____

By: _____

2864 E. Dorothy, Fresno CA, 93706

P.O. Box 10077, Fresno, CA 93745-0077

(559) 233-7156 800-882-5362 FAX: (559) 233-4284

www.parcenvironmental.com

without DB

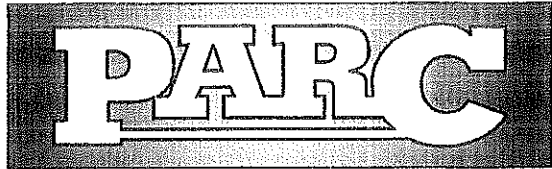

ENVIRONMENTAL

Solutions Made Easy

CA Lic. #501913 NV Lic. #0034638 DOSH Registration #19 Hauler Registration #2908 EPA #CAR000263707

24 Hour Emergency Spill Response • Asbestos Abatement • Lead Paint Removal • Hazardous Waste Hauling & Disposal
Soil Remediation • Site Assessments • Microbial Decontamination • Indoor Air Quality • Lab Packing • Hydroblasting

PROPOSAL

NO: 98-177R1

TO: Tulare Regional Medical Center

DATE: 5/29/18

ATTN: Sandra Gomez

PHONE: 559-685-3477

E-Mail: sgomez@tulareregional.org

JOB NAME: Asbestos Carpet/Glue Corridor Project – Tulare Regional Medical Center

PARC Environmental, hereinafter designated as PARC, proposes to perform the following Scope of work:

Scope of work:

Remove, transport, and dispose of Asbestos Containing Carpet Glue.

Price is based on the following:

1. Setup critical barriers, negative air pressure and containment in the Corridor.
2. Remove Baseboards, Carpet and Mastic in the corridor.
3. Carpet Glue to be removed with chemicals and buffers.
4. Dispose materials as Hazardous Waste with a signed manifest.
5. Power and water to be supplied to PARC at no additional cost.
6. Work to be done in one mobilization.
7. Work to be done during normal business hours.
8. Price includes all applicable APCD (\$960) fees and notifications.
9. Price is based on Non-Prevailing Wage Rates.

COST: \$22,716.00

- ✓ This proposal shall be incorporated into any contract and attached to it as an Exhibit.
- ✓ Retention shall be paid within 90 days of substantial completion of work by PARC.
- ✓ Unless otherwise noted, this is a lump sum proposal; quantities listed are informational only and not to be used for deductive pricing. Unless otherwise noted, price is based on non-prevailing wages.

PROPOSAL TERMS: All work shall be performed in accordance with state and federal regulations pertaining to abatement of hazardous materials including transportation and disposal of waste. PARC carries liability, worker's compensation, and auto insurance. Unless otherwise stated; the customer agrees to supply sufficient water and electricity at no cost to PARC; the customer acknowledges that abatement requires the application of tape and agrees that PARC will not be held responsible for tape damage or for repainting; this bid is based on performing the work during regular work hours; PARC shall not be responsible for weather protection or for damages resulting from weather or vandalism; this proposal is subject to change and may be withdrawn if not accepted within 30 days of the above date.

TRANSPORTATION OF WASTE TERMS: The Generator authorizes PARC Environmental to sign all transportation documents and waste profiles as "agent for the generator". PARC will forward all required documentation to Generator. PARC Environmental will abide by all local, state, and federal regulations when handling, packaging, and transporting all wastes.

PAYMENT TERMS: Cash forthwith for any portion of work commenced and completed in any one calendar month. Balance of contract price due and payable within 10 calendar days upon completion of PARC's work. Unpaid monies shall be subject to a finance charge of 1.5% per month. The customer agrees to compensate PARC for any collection related costs, including reasonable attorney fees, if full payment is not timely made to PARC. The customer agrees that the court of jurisdiction, for any claim, shall be located in Fresno County.

Accepted _____, 2018

PARC Environmental

By: _____

Approved:

Title: _____

By: _____

2864 E. Dorothy, Fresno CA, 93706

P.O. Box 10077, Fresno, CA 93745-0077

(559) 233-7156 800-882-5362 FAX: (559) 233-4284

www.parcenvironmental.com



ENVIRONMENTAL

Solutions Made Easy

CA Lic. #501913 NV Lic. #0034638 DOSH Registration #19 Hauler Registration #2908 EPA #CAR000263707

24 Hour Emergency Spill Response • Asbestos Abatement • Lead Paint Removal • Hazardous Waste Hauling & Disposal
Soil Remediation • Site Assessments • Microbial Decontamination • Indoor Air Quality • Lab Packing • Hydroblasting

PROPOSAL

NO: 98-222

TO: Tulare Regional Medical Center

DATE: 6/28/18

ATTN: Sandra Gomez

PHONE: 559-685-3477

E-Mail: sgomez@tulareregional.org

JOB NAME: Asbestos OR Rooms

PARC Environmental, hereinafter designated as PARC, proposes to perform the following Scope of work:

Scope of work:

Remove, transport, and dispose of Asbestos Containing Wall Glue behind Ceramic Tile.

Price is based on the following:

- 1. Setup critical barriers, negative air pressure and containment.
2. Remove the bottom wall ceramic tile/glue around in 3 OR Rooms.
3. Dispose materials as Non-Hazardous Waste with a signed manifest.
4. Power and water to be supplied to PARC at no additional cost.
5. Work to be done in one mobilization.
6. Work to be done during normal business hours.
7. Price is based on Non-Prevailing Wage Rates.

COST: \$3,817.00

- This proposal shall be incorporated into any contract and attached to it as an Exhibit.
Retention shall be paid within 90 days of substantial completion of work by PARC.
Unless otherwise noted, this is a lump sum proposal; quantities listed are informational only and not to be used for deductive pricing. Unless otherwise noted, price is based on non-prevailing wages.

PROPOSAL TERMS: All work shall be performed in accordance with state and federal regulations pertaining to abatement of hazardous materials including transportation and disposal of waste. PARC carries liability, worker's compensation, and auto insurance. Unless otherwise stated; the customer agrees to supply sufficient water and electricity at no cost to PARC; the customer acknowledges that abatement requires the application of tape and agrees that PARC will not be held responsible for tape damage or for repainting; this bid is based on performing the work during regular work hours; PARC shall not be responsible for weather protection or for damages resulting from weather or vandalism; this proposal is subject to change and may be withdrawn if not accepted within 30 days of the above date.

TRANSPORTATION OF WASTE TERMS: The Generator authorizes PARC Environmental to sign all transportation documents and waste profiles as "agent for the generator". PARC will forward all required documentation to Generator. PARC Environmental will abide by all local, state, and federal regulations when handling, packaging, and transporting all wastes.

PAYMENT TERMS: Cash forthwith for any portion of work commenced and completed in any one calendar month. Balance of contract price due and payable within 10 calendar days upon completion of PARC's work. Unpaid monies shall be subject to a finance charge of 1.5% per month. The customer agrees to compensate PARC for any collection related costs, including reasonable attorney fees, if full payment is not timely made to PARC. The customer agrees that the court of jurisdiction, for any claim, shall be located in Fresno County.

Accepted _____, 2018

By: _____

Title: _____

PARC Environmental

Approved:

By: _____

2864 E. Dorothy, Fresno CA, 93706
P.O. Box 10077, Fresno, CA 93745-0077
(559) 233-7156 800-882-5362 FAX: (559) 233-4284
www.parcenvironmental.com

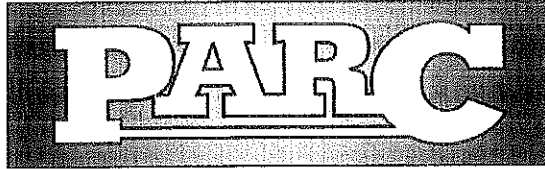

E N V I R O N M E N T A L

Solutions Made Easy

CA Lic. #501913 NV Lic. #0034638 DOSH Registration #19 Hauler Registration #2908 EPA #CAR000263707

24 Hour Emergency Spill Response • Asbestos Abatement • Lead Paint Removal • Hazardous Waste Hauling & Disposal
Soil Remediation • Site Assessments • Microbial Decontamination • Indoor Air Quality • Lab Packing • Hydroblasting

PROPOSAL

NO: 98-223

TO: Tulare Regional Medical Center

DATE: 6/28/18

ATTN: Sandra Gomez

PHONE: 559-685-3477

E-Mail: sgomez@tulareregional.org

JOB NAME: Asbestos floor tile – Med Room 2

PARC Environmental, hereinafter designated as PARC, proposes to perform the following Scope of work:

Scope of work:

Remove, transport, and dispose of Asbestos Containing floor tile/mastic.

Price is based on the following:

1. Setup critical barriers, negative air pressure and containment.
2. Remove center broken tiles on the floor and remove black mastic.
3. Dispose materials as Non-Hazardous Waste with a signed manifest.
4. Power and water to be supplied to PARC at no additional cost.
5. Work to be done in one mobilization.
6. Work to be done during normal business hours.
7. Price is based on Non-Prevailing Wage Rates.

COST: \$1,591.00

Add Alternate: \$493.00

- Remove all flooring in the room.

- This proposal shall be incorporated into any contract and attached to it as an Exhibit.
- Retention shall be paid within 90 days of substantial completion of work by PARC.
- Unless otherwise noted, this is a lump sum proposal; quantities listed are informational only and not to be used for deductive pricing. Unless otherwise noted, price is based on non-prevailing wages.

PROPOSAL TERMS: All work shall be performed in accordance with state and federal regulations pertaining to abatement of hazardous materials including transportation and disposal of waste. PARC carries liability, worker's compensation, and auto insurance. Unless otherwise stated; the customer agrees to supply sufficient water and electricity at no cost to PARC; the customer acknowledges that abatement requires the application of tape and agrees that PARC will not be held responsible for tape damage or for repainting; this bid is based on performing the work during regular work hours; PARC shall not be responsible for weather protection or for damages resulting from weather or vandalism; this proposal is subject to change and may be withdrawn if not accepted within 30 days of the above date.

TRANSPORTATION OF WASTE TERMS: The Generator authorizes PARC Environmental to sign all transportation documents and waste profiles as "agent for the generator". PARC will forward all required documentation to Generator. PARC Environmental will abide by all local, state, and federal regulations when handling, packaging, and transporting all wastes.

PAYMENT TERMS: Cash forthwith for any portion of work commenced and completed in any one calendar month. Balance of contract price due and payable within 10 calendar days upon completion of PARC's work. Unpaid monies shall be subject to a finance charge of 1.5% per

2864 E. Dorothy, Fresno CA, 93706
P.O. Box 10077, Fresno, CA 93745-0077
(559) 233-7156 800-882-5362 FAX: (559) 233-4284
www.parcenvironmental.com

month. The customer agrees to compensate PARC for any collection related costs, including reasonable attorney fees, if full payment is not timely made to PARC. The customer agrees that the court of jurisdiction, for any claim, shall be located in Fresno County.

Accepted _____, 2018

By: _____

Title: _____

PARC Environmental

Approved:

By: _____

2864 E. Dorothy, Fresno CA, 93706
P.O. Box 10077, Fresno, CA 93745-0077
(559) 233-7156 800-882-5362 FAX: (559) 233-4284
www.parcenvironmental.com



CENTRAL VALLEY ENVIRONMENTAL

Corporate Office- 4263 N Selland- Fresno, CA 93722- Ph: (559) 222-1122- FAX: (559) 222-1174
North Bay-135 Utility Court, Suite A- Rohnert Park, CA 94928- Ph: (707) 584-1900 -FAX: (707) 584-1911
CONTRACTOR'S LICENSE #: 913083 A, B, C-21, C-22, ASB, HAZ CAL-OSHA DOSH Reg#938
DIR Reg#1000001553

PROPOSAL – CVE # 18289- GP

Sandra Gomez
Sgomez@Tulareregional.org
TRMC
869 Cherry St
Tulare, CA 93274

July 10, 2018

Central Valley Environmental is pleased to provide the following proposal to furnish supervision, labor, and materials to perform the following scope of work at:

Tulare Regional Medical Center

Scope of Work: Asbestos Abatement

1. Mobilization of Crew and equipment.
2. Set up of engineering controls and establishment of negative pressure containment during Asbestos removal operations.
3. Remove and dispose of tile base with asbestos adhesive at entire perimeter of three OR rooms at 2nd floor
4. Remove and dispose VCT tile and mastic at 2nd floor medical room.
5. All contents and furniture needs to be removed before abatement can start.

Asbestos Abatement	\$19,775.00
Air Quality Fee	\$179.00
Total	\$19,954.00

Scope of Work: Asbestos Abatement

1. Mobilization of Crew and equipment.
2. Set up of engineering controls and establishment of negative pressure containment during Asbestos removal operations.
3. Remove and dispose of carpet tiles and asbestos carpet glue at 2nd floor hallway
4. Remove and dispose of carpet tiles and asbestos carpet glue at 2nd floor OB hallway
5. All contents and furniture needs to be removed before abatement can start.

Asbestos Abatement	\$68,444.00
Air Quality Fee	\$1,510.00
Total	\$69,954.00



CENTRAL VALLEY ENVIRONMENTAL

Corporate Office- 4263 N Selland- Fresno, CA 93722- Ph: (559) 222-1122- FAX: (559) 222-1174
North Bay-135 Utility Court, Suite A- Rohnert Park, CA 94928- Ph: (707) 584-1900 -FAX: (707) 584-1911
CONTRACTOR'S LICENSE #: 913083 A, B, C-21, C-22, ASB, HAZ CAL-OSHA DOSH Reg#938
DIR Reg#1000001553

PROPOSAL – CVE # 18289- GP

*All Asbestos work performed will be done with properly trained personnel and in accordance with all EPA, AHERA, Cal/OSHA, DOT, and all other Local, State and Federal Regulatory Agencies.

*Includes all hazardous waste hauling, disposal fees

Exclusions/Clarifications:

1. Any other asbestos abatement not noted in this proposal.
2. Third party air clearance not included.
3. Includes prevailing wage rates

PROPOSAL TERMS

This proposal is based upon our legal terms and conditions as included as part of this proposal. All work shall be performed in accordance with State and Federal regulations. Unless otherwise noted the customer agrees to provide a sufficient water supply to perform work mentioned above. This bid is based on performing the work during regular work hours. Central valley Environmental shall not be responsible for weather protection or for damages resulting from weather or vandalism; this proposal is subject to change and may be withdrawn if not accepted within 30 Days of the above mentioned date.

PAYMENT TERMS

Cash forthwith for any portion of work commenced and completed in any one calendar month. Balance of contract price due and payable within 10 days upon completion of Central Valley Environmental's work. Customer will incur a 3% convenience fee upon entire amount due if customer chooses to pay by credit card. Unpaid monies shall be subject to a finance charge of 1.5% per month. The customer agrees to compensate Central Valley Environmental for any collection related costs, including reasonable attorney fees, if full payment is not made to Central Valley Environmental. The customer agrees that the court of jurisdiction for any claim shall be located in Fresno County.

REQUIREMENTS

All Movable items shall be removed from the work area prior to mobilization of Central Valley Environmental crews and equipment unless otherwise stated in this proposal Central Valley Environmental will not be held responsible for items missing or loss during the course of work.

This project will be scheduled and worked on a straight time, normal working schedule of eight hours per day, Monday through Friday, excluding holidays.



CENTRAL VALLEY ENVIRONMENTAL

Corporate Office- 4263 N Selland- Fresno, CA 93722- Ph: (559) 222-1122- FAX: (559) 222-1174
North Bay-135 Utility Court, Suite A- Rohnert Park, CA 94928- Ph: (707) 584-1900 -FAX: (707) 584-1911
CONTRACTOR'S LICENSE #: 913083 A, B, C-21, C-22, ASB, HAZ CAL-OSHA DOSH Reg#938
DIR Reg#1000001553

PROPOSAL – CVE # 18289- GP

All prices in this proposal are based on one mobilization charge. If additional mobilization and/or demobilization is required, an additional mobilization and/or de-mobilization will be charged accordingly and paid for by the client.

The customer is responsible for removing all movable objects and furniture from the work area. Objects left in the work area will not be insured nor will repair cost be charged to Central Valley Environmental should damage occur. Heating, Ventilation and air-conditioning equipment supplying work area must be shut off.

This proposal is based upon our legal terms and conditions as included as part of this proposal. This proposal is subject to change and may be withdrawn if not accepted within (30) days of this date.

SITE ACCESS

Customer agrees to ensure that prior to any demo operations, abatement work etc. The work area and/or storage area shall be vacated and shall remain closed to all persons (other than Central Valley Environmental employees) for the duration of the project. In the event that any individual other than Central Valley Environmental employees enters the control area, customer agrees that Central Valley Environmental shall not be held liable for any claims relative for hazard exposure arising there from and that the customer will indemnify and defend Central Valley Environmental from such claims. Customer agrees that all authorized visitors shall read and sign Central Valley Environmental visitor policy form and/or the option of terminating this contract.

CHANGES AND EXTRA WORK

Customer may change the work at any time, including changes in scope methods, scheduling or performance requirements, in case the contract price and completion time will be adjusted accordingly.

DIFFERING SITE CONDITIONS

If Central Valley Environmental encounters subsurface or latent physical conditions at the site differing materially, or in quantity from those stated in the bid documents, and/ or unknown physical conditions at the site of an unusual nature, Central Valley Environmental will notify customer. If such conditions cause an increase in cost or the time required for performance of any part of the work an equitable adjustment in price and contract time modified accordingly.

FORCE MAJOR

Central Valley Environmental shall not be deemed in default nor be liable for damages for any failure or default in performance of its work which arise out of causes beyond its reasonable control. Such sovereign or contractual capacity, fires floods, epidemics, quarantine, restrictions, strikes, freight, embargos, material shortages, or unusually severe weather. In the event the work is delayed by such causes, the time and cost for performance and repair will be equitably adjusted.

AUTHORIZATION TO PROCEED

A Signature below by CLIENT constitutes an authorization to proceed with the scope of work in accordance with the price quotations and terms and conditions set forth in this document. This authorization shall constitute a valid and binding agreement of the CLIENT

By signing below you are hereby agreeing that you have read and understand the provisions contained herein and any attachments hereto.

Accepted and approved this _____ Day of _____ 2018

CUSTOMER SIGNATURE: _____



CENTRAL VALLEY ENVIRONMENTAL

Corporate Office- 4263 N Selland- Fresno, CA 93722- Ph: (559) 222-1122- FAX: (559) 222-1174
North Bay-135 Utility Court, Suite A- Rohnert Park, CA 94928- Ph: (707) 584-1900 -FAX: (707) 584-1911
CONTRACTOR'S LICENSE #: 913083 A, B, C-21, C-22, ASB, HAZ CAL-OSHA DOSH Reg#938
DIR Reg#1000001553

PROPOSAL – CVE # 18289- GP

PRINT NAME: _____ DATE: _____

**** PLEASE SIGN AUTHORIZATION TO PROCEED AND FAX ALL PAGES TO (559) 222-1174
or email to Gregp@cvecorp.com**

If you have any questions or concerns please contact Greg Paul on his cell phone at
(559) 978-1053.

THANK YOU FOR CHOOSING CENTRAL VALLEY ENVIRONMENTAL



CENTRAL VALLEY ENVIRONMENTAL

Corporate Office- 4263 N Selland- Fresno, CA 93722- Ph: (559) 222-1122- FAX: (559) 222-1174
North Bay-135 Utility Court, Suite A-- Rohnert Park, CA 94928- Ph: (707) 584-1900 --FAX: (707) 584-1911
CONTRACTOR'S LICENSE #: 913083 A, B, C-21, C-22, ASB, HAZ CAL-OSHA DOSH Reg#938
DIR Reg#1000001553

PROPOSAL – CVE # 18289- GP

PRELIMINARY INFORMATION REQUEST FORM

Please fill out and fax back to 559-222-1174 Or Email to
ValerieO@cvecorp.com

Central Valley Environmental is the sub-contractor on the following project. Would you please take a few minutes to answer some questions and provide the information requested. This form allows us to complete our project file and comply with the state/federal requirements that may exist regarding this project. This request in no way reflects the credit worthiness of any party named. Please return this form to fax 559-222-1174 or email ValerieO@cvecorp.com
You may also call 559-222-1122 with any questions or concerns.

Project Name _____

- What type of project is this? (circle one) Private Public Federal
- If a public or federal project, is there a payment bond? (Circle one) Yes No
- If yes, please provide the surety name & bond# _____

Please provide the name, address and phone number for each party listed below:

PROPERTY OWNER _____

General Contractor _____

Construction Lender _____

Other (If any) _____

PLEASE FILL OUT THE INFORMATION BELOW AND SEND INTO OUR OFFICE BEFORE THE START OF THE JOB.



CENTRAL VALLEY ENVIRONMENTAL

Corporate Office- 4263 N Selland- Fresno, CA 93722- Ph: (559) 222-1122- FAX: (559) 222-1174
North Bay-135 Utility Court, Suite A- Rohnert Park, CA 94928- Ph: (707) 584-1900 -FAX: (707) 584-1911
CONTRACTOR'S LICENSE #: 913083 A, B, C-21, C-22, ASB, HAZ CAL-OSHA DOSH Reg#938
DIR Reg#1000001553

PROPOSAL – CVE # 18289- GP

Owner's Name:

Contact Name (First & Last)

Owner's mailing address:

Owner's Telephone

Owner's Tax ID Number:

BILLING NAME & ADDRESS (where the invoice will be sent & who will pay for contract)

Owners US EPA Generator's temporary ID Number is required for all friable asbestos transportation and disposal

Please go to www.hwts.dtsc.ca.gov , complete the application for a Temporary EPA-ID if one has not been obtained yet. The State Board of Equalization will charge fees according to number of manifests generated. These fees are approximately \$10.00 per manifest. These fees are not included in Central Valley Environmental contract price. The owner will be sent the bill directly from SBE sometime within the calendar year.

All "Commercial" Properties will require the use of the Tax Identification number to obtain the EPA ID number.

CONSTRUCTION LENDER NAME ADDRESS (if applicable)

LEASEHOLD OWNER OR TRUST FUND NAME AND ADDRESS (if applicable)

Tulare Local Healthcare District dba Tulare Regional Medical Center

Agenda Item

Board Meeting Date: 07-17-18

Title to Appear on Agenda: Recommendation for Fire Alarm Systems repairs

Brief Description: Repair multiple deficiencies noted in annual fire alarm system inspection.

Background and Details: Multiple deficiencies noted during hospital annual fire alarm inspection. Certain Sprinkler heads are over 50 years old and need to be tested for functionality or replaced. Certain sprinkler heads are corroded and need to be replaced. Back up fire alarm batteries need to be replaced. Trouble shoot two smoke detectors connected to nursing station. These items are life safety 101, NFPA 25 and NFPA 99 components that MUST be corrected.

Sole bid obtained as the hospital has a standing agreement with Johnson Controls.

Inspection deficiency repairs-\$2,328.95

Sprinkler testing/repairs-\$15,064.85

Exhibits: See attached

Recommended Action: Hospital Board approve Johnson Controls to proceed with proposed scope of work delineated in proposals.



PROPOSAL AND SERVICE AGREEMENT

Johnson Controls Inspection SR# 41707970	Salesperson: Joseph Ochoa Employee ID: 171355 License No. 980647 C10, C16	Date: 7-5-2018
Customer: Tulare Regional Medical Center Location: 869 N Cherry St. Tulare, Ca 93274	Invoice To (if different from Customer): Customer P.O. #	

Contact: Sandra Gomez, Lionel Machado
Phone: 559-685-3477
Email: lmachado@tulareregional.org / sgomez@tulareregional.org

SUBJECT: Inspection Deficiency Quote:

A Johnson Controls technician performed a life safety inspection on your fire and life safety system(s). Upon completion of this inspection, the following deficiencies/ impairments were identified and need to be repaired:

First floor ER waiting; device duct detector M1-49 housing cover is damaged. The housing will not make a complete seal, this could effect the operation for which the device was designed.

Two fire alarm back up batteries are in need of replacement. They have exceed their service life per the manufacture recommendations.

A audio visual fire alarm notification device is missing its cover. Information will need to be gathered to replace device cover or possible the device if cover plate is not available.

The nuse station did not receive the alarm for smoke detectors for the following areas; room #102 (M1-15) and room #101 (M2-14).

Johnson Controls Fire Protection LP ("Company"), for and in consideration of the prices herein named, proposes to furnish the work, and/or materials hereinafter described, subject to the terms and conditions of this Agreement.

SCOPE OF WORK:

- Remove and replace the duct detector. This will insure the fire alarm device is operating as per design.
- Remove and replace the two back up fire alarm batteries. (12v7.2ah)
- Gather information needed to replace the cover for the A/V. If the A/V cover can not be replaced. Gather information to replace full device. (This part has not been figured into the quote, a return trip will be needed to replace cover or device.)
- Trouble shoot the two smoke detectors that did not report the nurses' station command station.

Johnson Controls Fire Protection LP ("Company"), is pleased to submit a quote in the amount of **\$2,328.95** to furnish mechanical labor and materials for the above listed scope of work.

___ Scope of Work continued on attached Amendment.

Johnson Controls qualifies the following:

1. During Johnson Controls Fire Protection LP normal working hours (M-F 8:00 a.m. – 4:00 p.m.), travel time shall be calculated on a per visit per person basis from local the Johnson Controls Fire Protection LP office location.
2. Unless otherwise directed, all work shall take place during our normal working hours.

Exclusions

1. Any unforeseen conditions within walls, ceilings and floors are excluded from this proposal.
2. Integrity of existing system field devices and wiring is excluded from this proposal.
3. Additional equipment or components not specified in scope of work.
4. Cutting, patching, or painting of building structures, including concrete cutting, coring, patching, or removal.
5. Scaffolding is excluded unless otherwise noted above.

Attached is a copy of our "General Terms & Conditions" which shall be made a part of this proposal. This proposal/quotation shall remain in effect for the next thirty (30) days

The terms of payment for invoices rendered against this order shall be net thirty (30) days from the date of invoice. Invoices may be rendered on a "progress" basis, and the customer agrees to pay such progress billings in full, in accordance with the terms of payment.

If this proposal meet your acceptance, kindly sign and return this document to my attention at your earliest convenience.

Please feel free to contact me directly at 559-312-9098 or email address joseph.choa@jci.com should you have any questions.

Thank you again for providing **Johnson Controls Fire Protection LP** the opportunity to service your fire protection needs.

Payment	NET 10 <input type="checkbox"/>	NET 30 <input type="checkbox"/>	C.O.D. <input type="checkbox"/>	DEPOSIT: \$
Time and Material	<input type="checkbox"/>	Price Not to Exceed \$	Fixed Price of \$2,328.95	BALANCE DUE: \$

CUSTOMER ACCEPTANCE
 In accepting this Agreement, Customer agrees to the terms and conditions contained herein including those on the following page(s) of this Agreement and any attachments or riders attached hereto that contain additional terms and conditions. It is understood that these terms and conditions shall prevail over any variation in terms and conditions on any purchase order or other document that the Customer may issue. Any changes in the system requested by the Customer after the execution of this Agreement shall be paid for by the Customer and such changes shall be authorized in writing. ATTENTION IS DIRECTED TO THE LIMITATION OF LIABILITY, WARRANTY, INDEMNITY AND OTHER CONDITIONS CONTAINED IN THIS AGREEMENT. This offer shall be void if not accepted in writing within thirty (30) days from the date first set forth above.

Customer _____
 By: _____
 Name: _____
 Title _____
 Billings Address: _____
 City, State, Zip: _____
 PO#: _____

JOHNSON CONTROLS FIRE PROTECTION LP
 By: Joseph Ochoa
 Name: Joseph Ochoa
 Title: Systems Integrity Representative
 Email: joseph.choa@jci.com
 Direct Line: (559) 312-9098
 License No: (980647): C10 C16

TERMS AND CONDITIONS (rev 5/18)

TERMS AND CONDITIONS

1. **Payment.** Payments shall be invoiced and due in accordance with the terms and conditions set forth above. Work performed on a time and material basis shall be at Company's then-prevailing rate for material, labor, and related items, in effect at the time supplied under this Agreement. Company shall invoice Customer for progress payments to one hundred (100%) percent based upon equipment delivered or stored, and services performed. Customers without established satisfactory credit shall make payments of cash in advance, upon delivery or as otherwise specified by Company. Where Customer establishes and maintains satisfactory credit, payments shall be due and payable thirty (30) days from date of invoice. Company reserves the right to revoke or modify Customer's credit in its sole discretion. Customer's failure to make payment when due is a material breach of this Agreement. If Customer fails to make any payment when due, in addition to any other rights and remedies available, Company shall have the right, at Company's sole discretion, to stop performing any Services and/or withhold further deliveries of materials, until the account is current. In the event payment is not received when due, Company may, at its discretion, assess late fees at the rate of 1.5% per month or the maximum rate allowed by law. Customer agrees to pay all costs of collection, including without limitation costs, fees, and attorneys' fees. Customer's failure to make payment when due is a material breach of this Agreement until the account is current.

2. **Pricing.** The pricing set forth in this Agreement is based on the number of devices to be installed and services to be performed as set forth in the Scope of Work ("Equipment" and "Services"). If the actual number of devices installed or services to be performed is greater than that set forth in the Scope of Work, the price will be increased accordingly. If this Agreement extends beyond one year, Company may increase prices upon notice to the Customer. Customer agrees to pay all taxes, permits, and other charges, including but not limited to state and local sales and excise taxes, however designated, levied or based on the service charges pursuant to this Agreement. Prices in any quotation or proposal from Company are subject to change upon notice sent to Customer at any time before the quotation or proposal has been accepted. Prices for products covered may be adjusted by Company, upon notice to Customer at any time prior to shipment, to reflect any increase in Company's cost of raw materials (e.g., steel, aluminum) incurred by Company after issuance of Company's applicable proposal or quotation.

3. **Alarm Monitoring Services.** Any reference to alarm monitoring services in this Agreement is included for pricing purposes only. Alarm monitoring services are performed pursuant to the terms and conditions of Company's standard alarm monitoring services agreement.

4. **Code Compliance.** Company does not undertake an obligation to inspect for compliance with laws or regulations unless specifically stated in the Scope of Work. Customer acknowledges that the Authority Having Jurisdiction (e.g. Fire Marshal) may establish additional requirements for compliance with local codes. Any additional services or equipment required will be provided at an additional cost to Customer.

5. **Limitation of Liability; Limitations of Remedy.** It is understood and agreed by the Customer that Company is not an insurer and that insurance coverage shall be obtained by the Customer and that amounts payable to company hereunder are based upon the value of the services and the scope of liability set forth in this Agreement and are unrelated to the value of the Customer's property and the property of others located on the premises. Customer agrees to look exclusively to the Customer's insurer to recover for injuries or damage in the event of any loss or injury and that Customer releases and waives all right of recovery against Company arising by way of subrogation. Company makes no guaranty or Warranty, including any implied warranty of merchantability or fitness for a particular purpose that equipment or services supplied by Company will detect or avert occurrences or the consequences therefrom that the equipment or service was designed to detect or avert. It is impractical and extremely difficult to fix the actual damages, if any, which may proximately result from failure on the part of Company to perform any of its obligations under this Agreement. Accordingly, Customer agrees that, Company shall be

exempt from liability for any loss, damage or injury arising directly or indirectly from occurrences, or the consequences therefrom, which the equipment or service was designed to detect or avert. Should Company be found liable for any loss, damage or injury arising from a failure of the equipment or service in any respect, Company's liability shall be limited to an amount equal to the Agreement price (as increased by the price for any additional work) or where the time and material payment term is selected, Customer's time and material payments to Company. Where this Agreement covers multiple sites, liability shall be limited to the amount of the payments allocable to the site where the incident occurred. Such sum shall be complete and exclusive. **IN NO EVENT SHALL COMPANY BE LIABLE FOR ANY DAMAGE, LOSS, INJURY, OR ANY OTHER CLAIM ARISING FROM ANY SERVICING, ALTERATIONS, MODIFICATIONS, CHANGES, OR MOVEMENTS OF THE COVERED SYSTEM(S) OR ANY OF ITS COMPONENT PARTS BY THE CUSTOMER OR ANY THIRD PARTY. COMPANY SHALL NOT BE LIABLE FOR INDIRECT, INCIDENTAL OR CONSEQUENTIAL DAMAGES OF ANY KIND, INCLUDING BUT NOT LIMITED TO DAMAGES ARISING FROM THE USE, LOSS OF THE USE, PERFORMANCE, OR FAILURE OF THE COVERED SYSTEM(S) TO PERFORM.** The limitations of liability set forth in this Agreement shall inure to the benefit of all parents, subsidiaries and affiliates of company, whether direct or indirect, company's employees, agents, officers and directors.

6. **Reciprocal Waiver of Claims (SAFETY Act).** Certain of Company's systems and services have received Certification and/or Designation as Qualified Anti-Terrorism Technologies ("QATT") under the Support Anti-terrorism by Fostering Effective Technologies Act of 2002, 6 U.S.C. §§ 441-444 (the "SAFETY Act"). As required under 6 C.F.R. 25.5 (e), to the maximum extent permitted by law, Company and Customer hereby agree to waive their right to make any claims against the other for any losses, including business interruption losses, sustained by either party or their respective employees, resulting from an activity resulting from an "Act of Terrorism" as defined in 6 C.F.R. 25.2, when QATT have been deployed in defense against, response to, or recovery from such Act of Terrorism.

7. **General Provisions.** Customer has selected the service level desired after considering and balancing various levels of protection afforded, and their related costs. All work to be performed by Company will be performed during normal working hours of normal working days (8:00 a.m. - 5:00 p.m., Monday through Friday, excluding Company holidays), as defined by Company, unless additional times are specifically described in this Agreement. Company will perform the services described in the Scope of Work section ("Services") for one or more system(s) or equipment as described in the Scope of Work section or the listed attachments ("Covered System(s)"). The Customer shall promptly notify Company of any malfunction in the Covered System(s) which comes to Customer's attention. This Agreement assumes the Covered System(s) are in operational and maintainable condition as of the Agreement date. If, upon initial inspection, Company determines that repairs are recommended, repair charges will be submitted for approval prior to any work. Should such repair work be declined Company shall be relieved from any and all liability arising therefrom. **UNLESS OTHERWISE SPECIFIED IN THIS AGREEMENT, ANY INSPECTION (AND, IF SPECIFIED, TESTING) PROVIDED UNDER THIS AGREEMENT DOES NOT INCLUDE ANY MAINTENANCE, REPAIRS, ALTERATIONS, REPLACEMENT OF PARTS, OR ANY FIELD ADJUSTMENTS WHATSOEVER, NOR DOES IT INCLUDE THE CORRECTION OF ANY DEFICIENCIES IDENTIFIED BY COMPANY TO CUSTOMER. COMPANY SHALL NOT BE RESPONSIBLE FOR EQUIPMENT FAILURE OCCURRING WHILE COMPANY IS IN THE PROCESS OF FOLLOWING ITS INSPECTION TECHNIQUES, WHERE THE FAILURE ALSO RESULTS FROM THE AGE OR OBSOLESCENCE OF THE ITEM OR DUE TO NORMAL WEAR AND TEAR. THIS AGREEMENT DOES NOT COVER SYSTEMS, EQUIPMENT, COMPONENTS OR PARTS THAT ARE BELOW GRADE, BEHIND WALLS OR OTHER OBSTRUCTIONS OR EXTERIOR TO THE BUILDING, ELECTRICAL WIRING, AND PIPING.**

8. **Customer Responsibilities.** Customer shall furnish all

necessary facilities for performance of its work by Company, adequate space for storage and handling of materials, light, water, heat, heat tracing, electrical service, local telephone, watchman, and crane and elevator service and necessary permits. Where wet pipe system is installed, Customer shall supply and maintain sufficient heat to prevent freezing of the system. Customer shall promptly notify Company of any malfunction in the Covered System(s) which comes to Customer's attention. This Agreement assumes any existing system(s) are in operational and maintainable condition as of the Agreement date. If, upon initial inspection, Company determines that repairs are recommended, repair charges will be submitted for approval prior to any work. Should such repair work be declined Company shall be relieved from any and all liability arising therefrom. Customer shall further:

- supply required schematics and drawings unless they are to be supplied by Company in accordance with this Agreement;
- Provide a safe work environment, in the event of an emergency or Covered System(s) failure, take reasonable safety precautions to protect against personal injury, death, and property damage, continue such measures until the Covered System(s) are operational, and notify Company as soon as possible under the circumstances.
- Provide Company access to any system(s) to be serviced,
- Comply with all laws, codes, and regulations pertaining to the equipment and/or services provided under this agreement.

9. **Repair Services (if Selected by Customer).** Where Customer expressly includes repair, replacement, and emergency response services in the Scope of Work, such services apply only to the components or equipment of the Covered System(s). Customer agrees to promptly request repair services in the event the System becomes inoperable or otherwise requires repair. The Agreement price does not include repairs to the Covered System(s) recommended by Company during the initial inspection, for which Company may submit independent pricing to customer and as to which Company will not proceed until Customer authorizes such work and approves the pricing. Repair or replacement of non-maintainable parts of the Covered System(s) including, but not limited to, unit cabinets, insulating material, electrical wiring, structural supports, and all other non-moving parts, is not included under this Agreement.

10. **System Equipment.** The purchase of equipment or peripheral devices (including but not limited to smoke detectors, passive infrared detectors, card readers, sprinkler system components, extinguishers and hoses) from Company shall be subject to the terms and conditions of this Agreement. If, in Company's sole judgment, any peripheral device or other system equipment, which is attached to the Covered System(s), whether provided by Company or a third party, interferes with the proper operation of the Covered System(s), Customer shall remove or replace such device or equipment promptly upon notice from Company. Failure of Customer to remove or replace the device shall constitute a material breach of this Agreement. If Customer adds any third party device or equipment to the Covered System(s), Company shall not be responsible for any damage to or failure of the Covered System(s) caused in whole or in part by such device or equipment.

11. **Reports.** Where inspection and/or test services are selected, such inspection and/or test shall be completed on Company's then current Report form, which shall be given to Customer, and, where applicable, Company may submit a copy thereof to the local authority having jurisdiction. The Report and recommendations by Company are only advisory in nature and are intended to assist Customer in reducing the risk of loss to property by indicating obvious defects or impairments noted to the system and equipment inspected and/or tested. They are not intended to imply that no other defects or hazards exist or that all aspects of the Covered System(s), equipment, and components are under control at the time of inspection. Final responsibility for the condition and operation of the Covered System(s) and equipment and components lies with Customer.

12. **Confined Space.** If access to confined space by Company is required for the performance of Services, Services shall be scheduled and performed in accordance with Company's then-current hourly rate.

13. **Hazardous Materials.** Customer represents that, except to the extent that Company has been given written notice of the following hazards prior to the execution of this Agreement, to the best of Customer's knowledge there is no:

- "permit confined space," as defined by OSHA,
- risk of infectious disease,
- need for air monitoring, respiratory protection, or other medical risk,
- asbestos, asbestos-containing material, formaldehyde or other potentially toxic or otherwise hazardous material contained in or on the surface of the floors, walls, ceilings, insulation or other structural components of the area of any building where work is required to be performed under this Agreement.

All of the above are hereinafter referred to as "Hazardous Conditions". Company shall have the right to rely on the representations listed above. If hazardous conditions are encountered by Company during the course of Company's work, the discovery of such materials shall constitute an event beyond Company's control and Company shall have no obligation to further perform in the area where the hazardous conditions exist until the area has been made safe by Customer as certified in writing by an independent testing agency, and Customer shall pay disruption expenses and re-mobilization expenses as determined by Company. This Agreement does not provide for the cost of capture, containment or disposal of any hazardous waste materials, or hazardous materials, encountered in any of the Covered System(s) and/or during performance of the Services. Said materials shall at all times remain the responsibility and property of Customer. Company shall not be responsible for the testing, removal or disposal of such hazardous materials.

14. Limited Warranty. COMPANY WARRANTS THAT ITS WORKMANSHIP AND MATERIAL FURNISHED UNDER THIS AGREEMENT WILL BE FREE FROM DEFECTS FOR A PERIOD OF NINETY (90) DAYS FROM THE DATE OF FURNISHING. Where Company provides product or equipment of others, Company will warrant the product or equipment only to the extent warranted by such third party. EXCEPT AS EXPRESSLY SET FORTH HEREIN, COMPANY DISCLAIMS ALL WARRANTIES, EXPRESS OR IMPLIED, INCLUDING BUT NOT LIMITED TO ANY IMPLIED WARRANTIES OF MERCHANTABILITY OR FITNESS FOR A PARTICULAR PURPOSE WITH RESPECT TO THE SERVICES PERFORMED OR THE PRODUCTS, SYSTEMS OR EQUIPMENT, IF ANY, SUPPORTED HEREUNDER.

15. Indemnity. Customer agrees to indemnify, hold harmless and defend Company against any and all losses, damages, costs, including expert fees and costs, and expenses including reasonable defense costs, arising from any and all third party claims for personal injury, death, property damage or economic loss, including specifically any damages resulting from the exposure of workers to Hazardous Conditions whether or not Customer pre-notifies Company of the existence of said hazardous conditions, arising in any way from any act or omission of Customer or Company relating in any way to this Agreement, including but not limited to the Services under this Agreement, whether such claims are based upon contract, warranty, tort (including but not limited to active or passive negligence), strict liability or otherwise. Company reserves the right to select counsel to represent it in any such action.

16. Insurance. Customer shall name Company, its officers, employees, agents, subcontractors, suppliers, and representatives as additional insureds on Customer's general liability and auto liability policies.

17. Commodities Availability. Company shall not be responsible for failure to provide services, deliver products, or otherwise perform work required by this Agreement due to lack of available steel products or products made from plastics or

other commodities. In the event Company is unable, after reasonable commercial efforts, to acquire and provide steel products, or products made from plastics or other commodities, if required to perform work required by this Agreement, Customer hereby agrees that Company may terminate the Agreement, or the relevant portion of the Agreement, at no additional cost and without penalty. Customer agrees to pay Company in full for all work performed up to the time of any such termination.

18. Exclusions. Unless expressly included in the Scope of Work, this Agreement expressly excludes, without limitation, testing inspection and repair of duct detectors, beam detectors, and UVIR equipment; provision of fire watches; clearing of ice blockage; draining of improperly pitched piping; replacement of batteries; recharging of chemical suppression systems; reloading of, upgrading, and maintaining computer software; system upgrades and the replacement of obsolete systems, equipment, components or parts; making repairs or replacements necessitated by reason of negligence or misuse of components or equipment or changes to Customer's premises, vandalism, corrosion (including but not limited to micro-bacterially induced corrosion ("MIC")), power failure, current fluctuation, failure due to non-Company installation, lightning, electrical storm, or other severe weather, water, accident, fire, acts of God or any other cause external to the Covered System(s). Repair Services provided pursuant to this Agreement do not cover and specifically excludes system upgrades and the replacement of obsolete systems, equipment, components or parts. All such services may be provided by Company at Company's sole discretion at an additional charge. If Emergency Services are expressly included in the scope of work section, the Agreement price does not include travel expenses.

19. Force Majeure. Company shall not be liable for any damage or penalty for delays or failure to perform work due to acts of God, acts or omissions of Customer, acts of civil or military authorities, Government regulations or priorities, fires, epidemics, quarantine, restrictions, war, riots, civil disobedience or unrest, strikes, delays in transportation, vehicle shortages, differences with workmen, inability to obtain necessary labor, material or manufacturing facilities, defaults of Company's subcontractors, failure or delay in furnishing complete information by Customer with respect to location or other details of work to be performed, impossibility or impracticability of performance or any other cause or causes beyond Company's control, whether or not similar to the foregoing.

20. Termination. Company may terminate this Agreement immediately at its sole discretion upon the occurrence of any Event of Default as hereinafter defined. Company may also terminate this Agreement at its sole discretion upon notice to Customer if Company's performance of its obligations under this Agreement becomes impracticable due to obsolescence of equipment at Customer's premises or unavailability of parts.

21. Default. An Event of Default shall be 1) failure of the Customer to pay any amount within ten (10) days after the amount is due and payable, 2) abuse of the System or the Equipment, 3) dissolution, termination, discontinuance, insolvency or business failure of Customer. Upon the occurrence of an Event of Default, Company may pursue one or more of the following remedies, 1) discontinue furnishing Services, 2) by written notice to Customer declare the balance of unpaid amounts due and to become due under the this Agreement to be immediately due and payable, provided that all past due amounts shall bear interest at the rate of 1 1/2% per month (18% per year) or the highest amount permitted by law,

3) receive immediate possession of any equipment for which Customer has not paid. 4) proceed at law or equity to enforce performance by Customer or recover damages for breach of this Agreement, and 5) recover all costs and expenses, including without limitation reasonable attorneys' fees, in connection with enforcing or attempting to enforce this Agreement.

22. No Option to Solicit. Customer shall not, directly or indirectly, on its own behalf or on behalf of any other person, business, corporation or entity, solicit or employ any Company employee, or induce any Company employee to leave his or her employment, for a period of two years after termination of this Agreement.

23. One-Year Limitation on Actions; Choice of Law. It is agreed that no suit, or cause of action or other proceeding shall be brought against either party more than one (1) year after the accrual of the cause of action or one (1) year after the claim arises, whichever is shorter, whether known or unknown when the claim arises or whether based on tort, contract, or any other legal theory. The laws of Massachusetts shall govern the validity, enforceability, and interpretation of this Agreement.

24. Assignment. Customer may not assign this Agreement without Company's prior written consent. Company may assign this Agreement to an affiliate without obtaining Customer's consent.

25. Entire Agreement. The parties intend this Agreement, together with any attachments or Riders (collectively the "Agreement") to be the final, complete and exclusive expression of their Agreement and the terms and conditions thereof. This Agreement supersedes all prior representations, understandings or agreements between the parties, written or oral, and shall constitute the sole terms and conditions of sale for all equipment and services. No waiver, change, or modification of any terms or conditions of this Agreement shall be binding on Company unless made in writing and signed by an Authorized Representative of Company.

26. Severability. If any provision of this Agreement is held by any court or other competent authority to be void or unenforceable in whole or in part, this Agreement will continue to be valid as to the other provisions and the remainder of the affected provision.

27. Legal Fees. Company shall be entitled to recover from the customer all reasonable legal fees incurred in connection with Company enforcing the terms and conditions of this Agreement.

28. License Information (Security System Customers): AL Alabama Electronic Security Board of Licensure 7956 Vaughn Road, Pmb 392, Montgomery, Alabama 36116 (334) 264-9388; AR Regulated by: Arkansas Board of Private Investigators And Private Security Agencies, #1 State Police Plaza Drive, Little Rock 72209 (501)618-8600; CA Alarm company operators are licensed and regulated by the Bureau of Security and Investigative Services, Department of Consumer Affairs, Sacramento, CA, 95814. Upon completion of the installation of the alarm system, the alarm company shall thoroughly instruct the purchaser in the proper use of the alarm system. Failure by the licensee, without legal excuse, to substantially commence work within 20 days from the approximate date specified in the agreement when the work will begin is a violation of the Alarm Company Act; NY Licensed by N.Y.S. Department of the State; TX Texas Commission on Private Security, 5805 N. Lamar Blvd., Austin, 78752-4422, 512-424-7710. License numbers available at www.jci.com or contact your local Johnson Controls office.



PROPOSAL AND SERVICE AGREEMENT

Johnson Controls Inspection SR# 41707972	Salesperson: Joseph Ochoa Employee ID: 171355 License No. 980647 C10, C16	Date: 7-5-2018
Customer: Tulare Regional Medical Center Location: 869 N Cherry St. Tulare, Ca 93274	Invoice To (if different from Customer): Customer P.O. #	

Contact: Lionel Machado, Sandra Gomez
 Phone: 559-685-3481
 Email: lmachado@tulareregional.org sgomez@tulareregional.org

SUBJECT: Inspection Deficiency Quote:

A Johnson Controls technician performed a life safety inspection on your fire and life safety system(s). Upon completion of this inspection, the following deficiencies/ impairments were identified and need to be repaired:

Our fire sprinkler inspectors have found 92 each fire sprinkler heads that have failed their inspection. The fire sprinkler heads are showing signs of corrosion and are in need of replacement. The inspectors also found 1each missing fire sprinkler escutcheon in the gift shop

The fire sprinkler inspectors also found 6 fire sprinkler systems that have been in service for 50 years or longer.

Recommend having the 74 each corroded fire sprinkler heads remove and replaced. Replace missing fire sprinkler escutcheon in the gift shop.

UL lab test will need to be performed per each riser that has fire sprinkler heads over 50 years.

NFPA 25 5.3.1.1.1

Where sprinkler shave been in service for 50 years, they shall be replaced or representative samples from one or sample area shall be tested

Johnson Controls Fire Protection LP ("Company"), for and in consideration of the prices herein named, proposes to furnish the work, and/or materials hereinafter described, subject to the terms and conditions of this Agreement.

SCOPE OF WORK:

- Fire sprinkler technician(s) will remove and replace 92 each fire sprinklers heads that are corroded or showing signs of corrosion.
- Replace missing fire sprinkler escutcheon in the gift shop(semi-recessed chrome ½ in)
- The technician will take sample of the fire sprinkler heads for systems that are over 50 years old (1% or 4ea. whichever is greater) Fire sprinkler heads will be sent to an independent lab for testing per riser. Sample heads will be replace with new fire sprinkler heads. A total of six fire sprinkler systems to have sample heads taken

Johnson Controls Fire Protection LP ("Company"), is pleased to submit a quote in the amount of **\$15,064.85** to furnish mechanical labor and materials for the above listed scope of work.

___ Scope of Work continued on attached Amendment.

Johnson Controls qualifies the following:

1. During Johnson Controls Fire Protection LP normal working hours (M-F 8:00 a.m. – 4:00 p.m.), travel time shall be calculated on a per visit per person basis from local the Johnson Controls Fire Protection LP office location.
2. Unless otherwise directed, all work shall take place during our normal working hours.

Exclusions

1. Any unforeseen conditions within walls, ceilings and floors are excluded from this proposal.
2. Integrity of existing system field devices and wiring is excluded from this proposal.
3. Additional equipment or components not specified in scope of work.
4. Cutting, patching, or painting of building structures, including concrete cutting, coring, patching, or removal.
5. Scaffolding is excluded unless otherwise noted above.

Attached is a copy of our "General Terms & Conditions" which shall be made a part of this proposal. This proposal/quotation shall remain in effect for the next thirty (30) days

The terms of payment for invoices rendered against this order shall be net thirty (30) days from the date of invoice. Invoices may be rendered on a "progress" basis, and the customer agrees to pay such progress billings in full, in accordance with the terms of payment.

If this proposal meet your acceptance, kindly sign and return this document to my attention at your earliest convenience.

Please feel free to contact me directly at 559-312-9098 or email address joseph.ochoa@jci.com should you have any questions.

Thank you again for providing **Johnson Controls Fire Protection LP** the opportunity to service your fire protection needs.

Payment	NET 10 <input type="checkbox"/>	NET 30 <input type="checkbox"/>	C.O.D. <input type="checkbox"/>	DEPOSIT: \$
Time and Material <input type="checkbox"/>	Price Not to Exceed \$	Fixed Price of \$15,064.85	BALANCE DUE: \$	

CUSTOMER ACCEPTANCE
 In accepting this Agreement, Customer agrees to the terms and conditions contained herein including those on the following page(s) of this Agreement and any attachments or riders attached hereto that contain additional terms and conditions. It is understood that these terms and conditions shall prevail over any variation in terms and conditions on any purchase order or other document that the Customer may issue. Any changes in the system requested by the Customer after the execution of this Agreement shall be paid for by the Customer and such changes shall be authorized in writing. ATTENTION IS DIRECTED TO THE LIMITATION OF LIABILITY, WARRANTY, INDEMNITY AND OTHER CONDITIONS CONTAINED IN THIS AGREEMENT. This offer shall be void if not accepted in writing within thirty (30) days from the date first set forth above.

Customer

JOHNSON CONTROLS FIRE PROTECTION LP

By: _____

By: Joseph Ochoa

Name: _____

Name: Joseph Ochoa
Title: Systems Integrity Representative

Title _____

Email: joseph.ochoa@jci.com

Billings Address: _____

Direct Line: (559) 312-9098

City, State, Zip: _____

License No: (980647): C10 C16

PO#: _____

TERMS AND CONDITIONS (rev 5/18)

TERMS AND CONDITIONS

1. **Payment.** Payments shall be invoiced and due in accordance with the terms and conditions set forth above. Work performed on a time and material basis shall be at Company's then-prevailing rate for material, labor, and related items, in effect at the time supplied under this Agreement. Company shall invoice Customer for progress payments to one hundred (100%) percent based upon equipment delivered or stored, and services performed. Customers without established satisfactory credit shall make payments of cash in advance, upon delivery or as otherwise specified by Company. Where Customer establishes and maintains satisfactory credit, payments shall be due and payable thirty (30) days from date of invoice. Company reserves the right to revoke or modify Customer's credit in its sole discretion. Customer's failure to make payment when due is a material breach of this Agreement. If Customer fails to make any payment when due, in addition to any other rights and remedies available, Company shall have the right, at Company's sole discretion, to stop performing any Services and/or withhold further deliveries of materials, until the account is current. In the event payment is not received when due, Company may, at its discretion, assess late fees at the rate of 1.5% per month or the maximum rate allowed by law. Customer agrees to pay all costs of collection, including without limitation costs, fees, and attorneys' fees. Customer's failure to make payment when due is a material breach of this Agreement until the account is current.

2. **Pricing.** The pricing set forth in this Agreement is based on the number of devices to be installed and services to be performed as set forth in the Scope of Work ("Equipment" and "Services"). If the actual number of devices installed or services to be performed is greater than that set forth in the Scope of Work, the price will be increased accordingly. If this Agreement extends beyond one year, Company may increase prices upon notice to the Customer. Customer agrees to pay all taxes, permits, and other charges, including but not limited to state and local sales and excise taxes, however designated, levied or based on the service charges pursuant to this Agreement. Prices in any quotation or proposal from Company are subject to change upon notice sent to Customer at any time before the quotation or proposal has been accepted. Prices for products covered may be adjusted by Company, upon notice to Customer at any time prior to shipment, to reflect any increase in Company's cost of raw materials (e.g., steel, aluminum) incurred by Company after issuance of Company's applicable proposal or quotation.

3. **Alarm Monitoring Services.** Any reference to alarm monitoring services in this Agreement is included for pricing purposes only. Alarm monitoring services are performed pursuant to the terms and conditions of Company's standard alarm monitoring services agreement.

4. **Code Compliance.** Company does not undertake an obligation to inspect for compliance with laws or regulations unless specifically stated in the Scope of Work. Customer acknowledges that the Authority Having Jurisdiction (e.g. Fire Marshal) may establish additional requirements for compliance with local codes. Any additional services or equipment required will be provided at an additional cost to Customer.

5. **Limitation of Liability; Limitations of Remedy.** It is understood and agreed by the Customer that Company is not an insurer and that insurance coverage shall be obtained by the Customer and that amounts payable to company hereunder are based upon the value of the services and the scope of liability set forth in this Agreement and are unrelated to the value of the Customer's property and the property of others located on the premises. Customer agrees to look exclusively to the Customer's insurer to recover for injuries or damage in the event of any loss or injury and that Customer releases and waives all right of recovery against Company arising by way of subrogation. Company makes no guaranty or Warranty, including any implied warranty of merchantability or fitness for a particular purpose that equipment or services supplied by Company will detect or avert occurrences or the consequences therefrom that the equipment or service was designed to detect or avert. It is impractical and extremely difficult to fix the actual damages, if any, which may proximately result from failure on the part of Company to perform any of its obligations under this Agreement. Accordingly, Customer agrees that, Company shall be

exempt from liability for any loss, damage or injury arising directly or indirectly from occurrences, or the consequences therefrom, which the equipment or service was designed to detect or avert. Should Company be found liable for any loss, damage or injury arising from a failure of the equipment or service in any respect, Company's liability shall be limited to an amount equal to the Agreement price (as increased by the price for any additional work) or where the time and material payment term is selected, Customer's time and material payments to Company. Where this Agreement covers multiple sites, liability shall be limited to the amount of the payments allocable to the site where the incident occurred. Such sum shall be complete and exclusive. **IN NO EVENT SHALL COMPANY BE LIABLE FOR ANY DAMAGE, LOSS, INJURY, OR ANY OTHER CLAIM ARISING FROM ANY SERVICING, ALTERATIONS, MODIFICATIONS, CHANGES, OR MOVEMENTS OF THE COVERED SYSTEM(S) OR ANY OF ITS COMPONENT PARTS BY THE CUSTOMER OR ANY THIRD PARTY. COMPANY SHALL NOT BE LIABLE FOR INDIRECT, INCIDENTAL OR CONSEQUENTIAL DAMAGES OF ANY KIND, INCLUDING BUT NOT LIMITED TO DAMAGES ARISING FROM THE USE, LOSS OF THE USE, PERFORMANCE, OR FAILURE OF THE COVERED SYSTEM(S) TO PERFORM.** The limitations of liability set forth in this Agreement shall inure to the benefit of all parents, subsidiaries and affiliates of company, whether direct or indirect, company's employees, agents, officers and directors.

6. **Reciprocal Waiver of Claims (SAFETY Act).** Certain of Company's systems and services have received Certification and/or Designation as Qualified Anti-Terrorism Technologies ("QATT") under the Support Anti-terrorism by Fostering Effective Technologies Act of 2002, 6 U.S.C. §§ 441-444 (the "SAFETY Act"). As required under 6 C.F.R. 25.5 (e), to the maximum extent permitted by law, Company and Customer hereby agree to waive their right to make any claims against the other for any losses, including business interruption losses, sustained by either party or their respective employees, resulting from an activity resulting from an "Act of Terrorism" as defined in 6 C.F.R. 25.2, when QATT have been deployed in defense against, response to, or recovery from such Act of Terrorism.

7. **General Provisions.** Customer has selected the service level desired after considering and balancing various levels of protection afforded, and their related costs. All work to be performed by Company will be performed during normal working hours of normal working days (8:00 a.m. - 5:00 p.m., Monday through Friday, excluding Company holidays), as defined by Company, unless additional times are specifically described in this Agreement. Company will perform the services described in the Scope of Work section ("Services") for one or more system(s) or equipment as described in the Scope of Work section or the listed attachments ("Covered System(s)"). The Customer shall promptly notify Company of any malfunction in the Covered System(s) which comes to Customer's attention. This Agreement assumes the Covered System(s) are in operational and maintainable condition as of the Agreement date. If, upon initial inspection, Company determines that repairs are recommended, repair charges will be submitted for approval prior to any work. Should such repair work be declined, Company shall be relieved from any and all liability arising therefrom. **UNLESS OTHERWISE SPECIFIED IN THIS AGREEMENT, ANY INSPECTION (AND, IF SPECIFIED, TESTING) PROVIDED UNDER THIS AGREEMENT DOES NOT INCLUDE ANY MAINTENANCE, REPAIRS, ALTERATIONS, REPLACEMENT OF PARTS, OR ANY FIELD ADJUSTMENTS WHATSOEVER, NOR DOES IT INCLUDE THE CORRECTION OF ANY DEFICIENCIES IDENTIFIED BY COMPANY TO CUSTOMER. COMPANY SHALL NOT BE RESPONSIBLE FOR EQUIPMENT FAILURE OCCURRING WHILE COMPANY IS IN THE PROCESS OF FOLLOWING ITS INSPECTION TECHNIQUES, WHERE THE FAILURE ALSO RESULTS FROM THE AGE OR OBSOLESCENCE OF THE ITEM OR DUE TO NORMAL WEAR AND TEAR. THIS AGREEMENT DOES NOT COVER SYSTEMS, EQUIPMENT, COMPONENTS OR PARTS THAT ARE BELOW GRADE, BEHIND WALLS OR OTHER OBSTRUCTIONS OR EXTERIOR TO THE BUILDING, ELECTRICAL WIRING, AND PIPING.**

8. **Customer Responsibilities.** Customer shall furnish all

necessary facilities for performance of its work by Company, adequate space for storage and handling of materials, light, water, heat, heat tracing, electrical service, local telephone, watchman, and crane and elevator service and necessary permits. Where wet pipe system is installed, Customer shall supply and maintain sufficient heat to prevent freezing of the system. Customer shall promptly notify Company of any malfunction in the Covered System(s) which comes to Customer's attention. This Agreement assumes any existing system(s) are in operational and maintainable condition as of the Agreement date. If, upon initial inspection, Company determines that repairs are recommended, repair charges will be submitted for approval prior to any work. Should such repair work be declined, Company shall be relieved from any and all liability arising therefrom. Customer shall further:

- supply required schematics and drawings unless they are to be supplied by Company in accordance with this Agreement;
- Provide a safe work environment, in the event of an emergency or Covered System(s) failure, take reasonable safety precautions to protect against personal injury, death, and property damage, continue such measures until the Covered System(s) are operational, and notify Company as soon as possible under the circumstances.
- Provide Company access to any system(s) to be serviced,
- Comply with all laws, codes, and regulations pertaining to the equipment and/or services provided under this agreement.

9. **Repair Services (if Selected by Customer).** Where Customer expressly includes repair, replacement, and emergency response services in the Scope of Work, such services apply only to the components or equipment of the Covered System(s). Customer agrees to promptly request repair services in the event the System becomes inoperable or otherwise requires repair. The Agreement price does not include repairs to the Covered System(s) recommended by Company during the initial inspection, for which Company may submit independent pricing to customer and as to which Company will not proceed until Customer authorizes such work and approves the pricing. Repair or replacement of non-maintainable parts of the Covered System(s) including, but not limited to, unit cabinets, insulating material, electrical wiring, structural supports, and all other non-moving parts, is not included under this Agreement.

10. **System Equipment.** The purchase of equipment or peripheral devices (including but not limited to smoke detectors, passive infrared detectors, card readers, sprinkler system components, extinguishers and hoses) from Company shall be subject to the terms and conditions of this Agreement. If, in Company's sole judgment, any peripheral device or other system equipment, which is attached to the Covered System(s), whether provided by Company or a third party, interferes with the proper operation of the Covered System(s), Customer shall remove or replace such device or equipment promptly upon notice from Company. Failure of Customer to remove or replace the device shall constitute a material breach of this Agreement. If Customer adds any third party device or equipment to the Covered System(s), Company shall not be responsible for any damage to or failure of the Covered System(s) caused in whole or in part by such device or equipment.

11. **Reports.** Where inspection and/or test services are selected, such inspection and/or test shall be completed on Company's then current Report form, which shall be given to Customer, and, where applicable, Company may submit a copy thereof to the local authority having jurisdiction. The Report and recommendations by Company are only advisory in nature and are intended to assist Customer in reducing the risk of loss to property by indicating obvious defects or impairments noted to the system and equipment inspected and/or tested. They are not intended to imply that no other defects or hazards exist or that all aspects of the Covered System(s), equipment, and components are under control at the time of inspection. Final responsibility for the condition and operation of the Covered System(s) and equipment and components lies with Customer.

12. **Confined Space.** If access to confined space by Company is required for the performance of Services, Services shall be scheduled and performed in accordance with Company's then-current hourly rate.

13. **Hazardous Materials.** Customer represents that, except to the extent that Company has been given written notice of the following hazards prior to the execution of this Agreement, to the best of Customer's knowledge there is no:

- "permit confined space," as defined by OSHA,
- risk of infectious disease,
- need for air monitoring, respiratory protection, or other medical risk,
- asbestos, asbestos-containing material, formaldehyde or other potentially toxic or otherwise hazardous material contained in or on the surface of the floors, walls, ceilings, insulation or other structural components of the area of any building where work is required to be performed under this Agreement.

All of the above are hereinafter referred to as "Hazardous Conditions". Company shall have the right to rely on the representations listed above. If hazardous conditions are encountered by Company during the course of Company's work, the discovery of such materials shall constitute an event beyond Company's control and Company shall have no obligation to further perform in the area where the hazardous conditions exist until the area has been made safe by Customer as certified in writing by an independent testing agency, and Customer shall pay disruption expenses and re-mobilization expenses as determined by Company. This Agreement does not provide for the cost of capture, containment or disposal of any hazardous waste materials, or hazardous materials, encountered in any of the Covered System(s) and/or during performance of the Services. Said materials shall at all times remain the responsibility and property of Customer. Company shall not be responsible for the testing, removal or disposal of such hazardous materials.

14. Limited Warranty. COMPANY WARRANTS THAT ITS WORKMANSHIP AND MATERIAL FURNISHED UNDER THIS AGREEMENT WILL BE FREE FROM DEFECTS FOR A PERIOD OF NINETY (90) DAYS FROM THE DATE OF FURNISHING. Where Company provides product or equipment of others, Company will warrant the product or equipment only to the extent warranted by such third party. EXCEPT AS EXPRESSLY SET FORTH HEREIN, COMPANY DISCLAIMS ALL WARRANTIES, EXPRESS OR IMPLIED, INCLUDING BUT NOT LIMITED TO ANY IMPLIED WARRANTIES OF MERCHANTABILITY OR FITNESS FOR A PARTICULAR PURPOSE WITH RESPECT TO THE SERVICES PERFORMED OR THE PRODUCTS, SYSTEMS OR EQUIPMENT, IF ANY, SUPPORTED HEREUNDER.

15. Indemnity. Customer agrees to indemnify, hold harmless and defend Company against any and all losses, damages, costs, including expert fees and costs, and expenses including reasonable defense costs, arising from any and all third party claims for personal injury, death, property damage or economic loss, including specifically any damages resulting from the exposure of workers to Hazardous Conditions whether or not Customer pre-notifies Company of the existence of said hazardous conditions, arising in any way from any act or omission of Customer or Company relating in any way to this Agreement, including but not limited to the Services under this Agreement, whether such claims are based upon contract, warranty, tort (including but not limited to active or passive negligence), strict liability or otherwise. Company reserves the right to select counsel to represent it in any such action.

16. Insurance. Customer shall name Company, its officers, employees, agents, subcontractors, suppliers, and representatives as additional insureds on Customer's general liability and auto liability policies.

17. Commodities Availability. Company shall not be responsible for failure to provide services, deliver products, or otherwise perform work required by this Agreement due to lack of available steel products or products made from plastics or

other commodities. In the event Company is unable, after reasonable commercial efforts, to acquire and provide steel products, or products made from plastics or other commodities, if required to perform work required by this Agreement, Customer hereby agrees that Company may terminate the Agreement, or the relevant portion of the Agreement, at no additional cost and without penalty. Customer agrees to pay Company in full for all work performed up to the time of any such termination.

18. Exclusions. Unless expressly included in the Scope of Work, this Agreement expressly excludes, without limitation, testing inspection and repair of duct detectors, beam detectors, and UV/IR equipment; provision of fire watches; clearing of ice blockage; draining of improperly pitched piping; replacement of batteries; recharging of chemical suppression systems; reloading of, upgrading, and maintaining computer software; system upgrades and the replacement of obsolete systems, equipment, components or parts; making repairs or replacements necessitated by reason of negligence or misuse of components or equipment or changes to Customer's premises, vandalism, corrosion (including but not limited to micro-bacterially induced corrosion ("MIC")), power failure, current fluctuation, failure due to non-Company installation, lightning, electrical storm, or other severe weather, water, accident, fire, acts of God or any other cause external to the Covered System(s). Repair Services provided pursuant to this Agreement do not cover and specifically excludes system upgrades and the replacement of obsolete systems, equipment, components or parts. All such services may be provided by Company at Company's sole discretion at an additional charge. If Emergency Services are expressly included in the scope of work section, the Agreement price does not include travel expenses.

19. Force Majeure. Company shall not be liable for any damage or penalty for delays or failure to perform work due to acts of God, acts or omissions of Customer, acts of civil or military authorities, Government regulations or priorities, fires, epidemics, quarantine, restrictions, war, riots, civil disobedience or unrest, strikes, delays in transportation, vehicle shortages, differences with workmen, inability to obtain necessary labor, material or manufacturing facilities, defaults of Company's subcontractors, failure or delay in furnishing complete information by Customer with respect to location or other details of work to be performed, impossibility or impracticability of performance or any other cause or causes beyond Company's control, whether or not similar to the foregoing.

20. Termination. Company may terminate this Agreement immediately at its sole discretion upon the occurrence of any Event of Default as hereinafter defined. Company may also terminate this Agreement at its sole discretion upon notice to Customer if Company's performance of its obligations under this Agreement becomes impracticable due to obsolescence of equipment at Customer's premises or unavailability of parts.

21. Default. An Event of Default shall be 1) failure of the Customer to pay any amount within ten (10) days after the amount is due and payable, 2) abuse of the System or the Equipment, 3) dissolution, termination, discontinuance, insolvency or business failure of Customer. Upon the occurrence of an Event of Default, Company may pursue one or more of the following remedies, 1) discontinue furnishing Services, 2) by written notice to Customer declare the balance of unpaid amounts due and to become due under the this Agreement to be immediately due and payable, provided that all past due amounts shall bear interest at the rate of 1 1/2% per month (18% per year) or the highest amount permitted by law,

3) receive immediate possession of any equipment for which Customer has not paid. 4) proceed at law or equity to enforce performance by Customer or recover damages for breach of this Agreement, and 5) recover all costs and expenses, including without limitation reasonable attorneys' fees, in connection with enforcing or attempting to enforce this Agreement.

22. No Option to Solicit. Customer shall not, directly or indirectly, on its own behalf or on behalf of any other person, business, corporation or entity, solicit or employ any Company employee, or induce any Company employee to leave his or her employment, for a period of two years after termination of this Agreement.

23. One-Year Limitation on Actions; Choice of Law. It is agreed that no suit, or cause of action or other proceeding shall be brought against either party more than one (1) year after the accrual of the cause of action or one (1) year after the claim arises, whichever is shorter, whether known or unknown when the claim arises or whether based on tort, contract, or any other legal theory. The laws of Massachusetts shall govern the validity, enforceability, and interpretation of this Agreement.

24. Assignment. Customer may not assign this Agreement without Company's prior written consent. Company may assign this Agreement to an affiliate without obtaining Customer's consent.

25. Entire Agreement. The parties intend this Agreement, together with any attachments or Riders (collectively the "Agreement") to be the final, complete and exclusive expression of their Agreement and the terms and conditions thereof. This Agreement supersedes all prior representations, understandings or agreements between the parties, written or oral, and shall constitute the sole terms and conditions of sale for all equipment and services. No waiver, change, or modification of any terms or conditions of this Agreement shall be binding on Company unless made in writing and signed by an Authorized Representative of Company.

26. Severability. If any provision of this Agreement is held by any court or other competent authority to be void or unenforceable in whole or in part, this Agreement will continue to be valid as to the other provisions and the remainder of the affected provision.

27. Legal Fees. Company shall be entitled to recover from the customer all reasonable legal fees incurred in connection with Company enforcing the terms and conditions of this Agreement.

28. License Information (Security System Customers): AL Alabama Electronic Security Board of Licensure 7956 Vaughn Road, Pmb 392, Montgomery, Alabama 36116 (334) 264-9388; AR Regulated by: Arkansas Board of Private Investigators And Private Security Agencies, #1 State Police Plaza Drive, Little Rock 72209 (501)618-8600; CA Alarm company operators are licensed and regulated by the Bureau of Security and Investigative Services, Department of Consumer Affairs, Sacramento, CA, 95814. Upon completion of the installation of the alarm system, the alarm company shall thoroughly instruct the purchaser in the proper use of the alarm system. Failure by the licensee, without legal excuse, to substantially commence work within 20 days from the approximate date specified in the agreement when the work will begin is a violation of the Alarm Company Act: NY Licensed by N.Y.S. Department of the State: TX Texas Commission on Private Security, 5805 N. Lamar Blvd., Austin, 78752-4422, 512-424-7710. License numbers available at www.jci.com or contact your local Johnson Controls office.

Tulare Local Healthcare District dba Tulare Regional Medical Center

Agenda Item

Board Meeting Date: 07-17-18

Title to Appear on Agenda: Recommendation for flooring installation/Repair

Brief Description: Vinyl Welded floor installation for 2nd Floor, ER, OB, Security Desk area, Lab and ER restrooms. VCT tile flooring for MS2 Med Surg Med. Room.

Background and Details: Areas specific to 2nd Floor from the OR-ICU and OB are all carpeted areas which needed to be removed for Infection control measures. Carpet is much deteriorated in certain areas. ER flooring is not in compliance with infection control measures and poses an infection control risk. Security Desk area, Lab and ER restrooms flooring has tears in the flooring and there again is an infection control risk. This is to comply with Title 24 and Title 22.

Bids obtained, see attached

ER flooring-\$22,114.32

2nd Floor hallways and OB hallway-\$28,469.84

Recovery room-\$462

Lab-\$8,123.79

MS2 Med room-\$1,286.24

ER registration-\$3,662.04

ER security-\$795.66

ER restrooms-\$1777.89

Exhibits: See attached

Recommended Action: Hospital Board approve Coulter's Flooring America to proceed with proposed scope of work delineated in proposals.

COULTER'S FLOORING AMERICA
 2309 EAST TULARE AVE
 CONTRACTORS LIC # 534223
 TULARE, CA 93274
 Telephone: 559-686-3450 Fax: 559-686-1780

ES813582

QUOTE

Sold To	Ship To
TULARE REGIONAL MEDICAL CENTER 869 N. CHERRY ST. TULARE, CA 93274	TULARE REGIONAL MEDICAL CENTER ER TULARE, CA 93274

Quote Date	Tele #1	PO Number	Quote Number
05/30/18	559-688-0821		ES813582

Inventory	Style/Item	Color/Description	Quantity	Units	Price	Extension
V-82 4G	BIOSPEC FB - 6'6"	TO BE CHOSEN	2,079.00	SF	4.77	9,916.83
Id #: V-82	V-82 MANN ADHESIVE	V-82 MANN 4 GAL ADHESIVE	3.00	PA	153.28	459.84
1	WELDING RODS	WELD RODS	3.00	EA	54.15	162.45
PREV WEEKDAY SCRAPE UP & PREP CARPET	PREV WEEKDAY SCRAPE UP & PREP CARPET		2,079.00	SF	1.10	2,286.90
PREV WAGE WKDAY HEAT WELD	PREV WAGE WKDAY HEAT WELD		2,079.00	LF	1.94	4,033.26
PREV WAGE WKDY VINYL COVING	PREV WAGE WKDY VINYL COVING		453.00	LF	7.02	3,180.06
TAKE UP PW WKDAY	PREV WAGE WKDY LAMINATE TAKE UP		2,079.00	SF	0.66	1,372.14
VINYL CAP S - COL901S	VINYL CAP S - 1/8 LINO CAP SILV	SILVER	684.00	LF	0.61	417.24
COVE STICK P	COVE STICK PLASTIC	COVE STICK PLASTIC	136.00	EA	2.10	285.60

— 05/30/18 —

4:25PM —

Sales Representative(s):
 GREG GIBSON

Sub Total: 22,114.32
 Sales Tax: 0.00
 Misc. Tax: 0.00

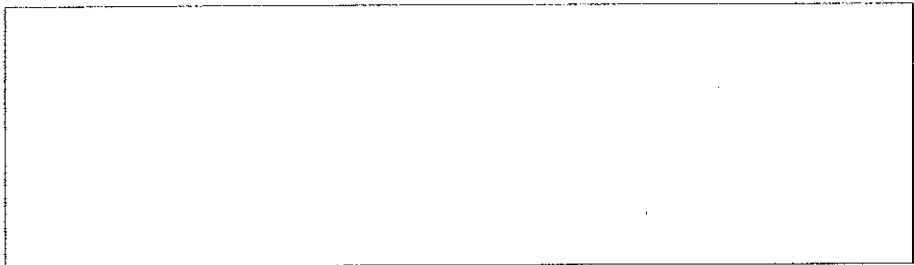

QUOTE TOTAL: \$22,114.32

COULTER'S FLOORING AMERICA
 2309 EAST TULARE AVE
 CONTRACTORS LIC # 534223
 TULARE, CA 93274
 Telephone: 559-686-3450 Fax: 559-686-1780

ES813582

QUOTE

Sold To TULARE REGIONAL MEDICAL CENTER 869 N. CHERRY ST. TULARE, CA 93274	Ship To TULARE REGIONAL MEDICAL CENTER ER TULARE, CA 93274
---	--

Quote Date 05/30/18	Tele #1 559-688-0821	PO Number	Quote Number ES813582
-------------------------------	--------------------------------	------------------	---------------------------------

Inventory	Style/Item	Color/Description	Quantity	Units	Price	Extension
-----------	------------	-------------------	----------	-------	-------	-----------

INSTALL COMMERCIAL HEAT WELD VINYL IN THE ER
 VINYL TO BE FULL COVERED

***PRICE INCLUDE TEAR OUT AND DISPOSAL OF OLD LAMINATE AND VINYL FLOOR UNDER THE
 LAMINATE**

*****PRICE DOES NOT INCLUDE MOVING OF CONTENTS*****

LABOR BASED ON REGULAR WORK DAY HOURS MONDAY-FRIDAY**

— 05/30/18 —

4:25PM —

Sales Representative(s):
 GREG GIBSON

Sub Total: 22,114.32
 Sales Tax: 0.00
 Misc. Tax: 0.00

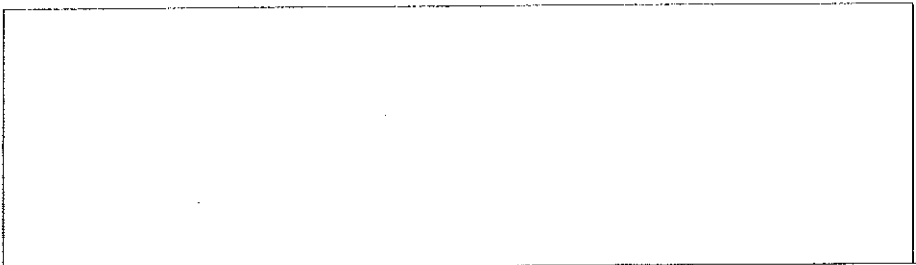

QUOTE TOTAL: \$22,114.32

COULTER'S FLOORING AMERICA
 2309 EAST TULARE AVE
 CONTRACTORS LIC # 534223
 TULARE, CA 93274
 Telephone: 559-686-3450 Fax: 559-686-1780

ES813854

QUOTE

Sold To	Ship To
TULARE REGIONAL MEDICAL CENTER 869 N. CHERRY ST. TULARE, CA 93274	TULARE REGIONAL MEDICAL CENTER 2ND FLOOR MAIN HALLWAY WAITING ROOM AND HALL TO ROOF TULARE, CA 93274

Quote Date	Tele #1	PO Number	Quote Number
07/03/18	559-688-0821		ES813854

Inventory	Style/Item	Color/Description	Quantity	Units	Price	Extension
DUR9525	ALTRO WOOD 9525 WEBCRETE 95 25LB FORTIFIED CEMENT PATCH	ANTIQUE WALNUT WEBCRETE 9525	2,671.48	SF	4.75	12,689.53
			8.00	EA	22.88	183.04
ECOFIX 20 E-4 GAL	ECOFIX 20 E-4 GAL	ADHESIVE	5.00	EA	225.30	1,126.50
/	HEAT WELD	HEAT WELDING RODS	4.00	EA	72.00	288.00
JOHNSONITE 6 DC-	JOHNSONITE 6X48X1/8-W/TOE DC-	BROWN	113.00	PC	7.01	792.13
	Id #: JOHNSONITE 6 DC-					
440 30OZ COVE ADH	440 30OZ COVE BASE	H-595 440 30 OZ (H-595 30 OZ COVE BASE ADHESIVE	14.00	EA	7.13	99.82
PREVAILING WAGE WEEKDAY	PREV WEEKDAY INSTALL TSB 6"		452.00	LF	1.92	867.84
633-701	REDUCER 1/8" TILE BLACK Id #: BUTT REDUCER	BLACK 701	9.00	PC	5.85	52.65
326-701	UNDERSLUNG REDUCER Id #: 326-701	BLACK	9.00	EA	14.05	126.45
BOSTIK 425 MULTI- PURPOSE BOSC05	BOSTIK 425 MULTI-PURPOSE ACRYLIC LATEX ADMIXTURE 1 GAL	NONE	8.00	EA	17.76	142.08
PREV WAGE WKDAY HEAT WELD	PREV WAGE WKDAY HEAT WELD		2,671.48	LF	3.50	9,350.18
PREV WAGE VINYL PREP SF	PREV WAGE VINYL PREP SF		2,671.48	SF	1.03	2,751.62

— 07/05/18 —

7:34AM —

Sales Representative(s):
GREG GIBSON

Sub Total: 28,469.84
 Sales Tax: 0.00
 Misc. Tax: 0.00

QUOTE TOTAL: \$28,469.84

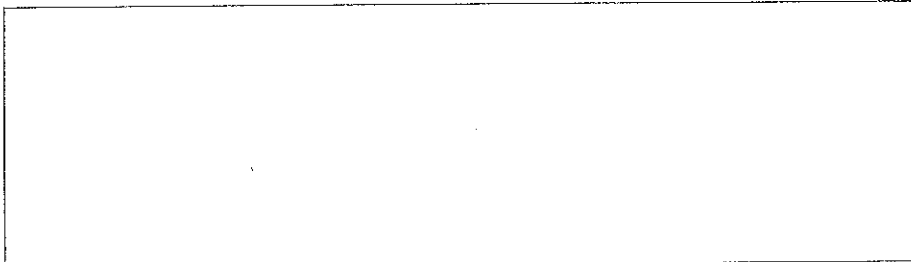

COULTER'S FLOORING AMERICA
 2309 EAST TULARE AVE
 CONTRACTORS LIC # 534223
 TULARE, CA 93274
 Telephone: 559-686-3450 Fax: 559-686-1780

ES813854

QUOTE

Sold To TULARE REGIONAL MEDICAL CENTER 869 N. CHERRY ST. TULARE, CA 93274	Ship To TULARE REGIONAL MEDICAL CENTER 2ND FLOOR MAIN HALLWAY WAITING ROOM AND HALL TO ROOF TULARE, CA 93274
---	---

Quote Date 07/03/18	Tele #1 559-688-0821	PO Number	Quote Number ES813854
-------------------------------	--------------------------------	------------------	---------------------------------

Inventory	Style/Item	Color/Description	Quantity	Units	Price	Extension
-----------	------------	-------------------	----------	-------	-------	-----------

INSTALL COMMERCIAL HEAT WELD VINYL IN 2ND FLOOR HALLWAYS AND WAITING ROOM
 PRICE INCLUDES ALL FLOOR PREP
 INSTALL NEW 6" RUBBER COVEBASE
 *****OLD FLOORING TO BE TAKEN UP AND DISPOSED OF BY OTHERS
 *****PRICE BASED REGULAR PREVAILING WORKDAY HOURS*****

— 07/05/18 — 7:34AM --
 Sales Representative(s): Sub Total: 28,469.84
 GREG GIBSON Sales Tax: 0.00
Misc. Tax: 0.00

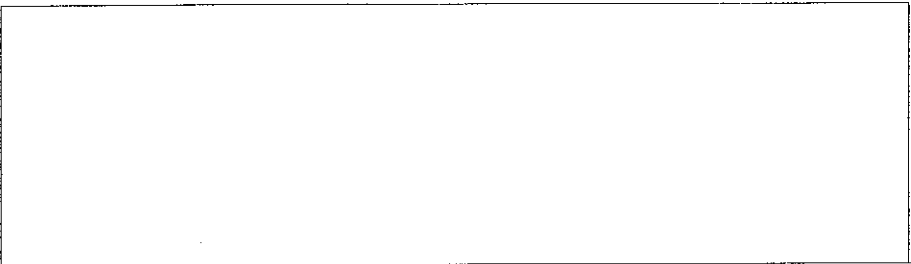

QUOTE TOTAL: \$28,469.84

COULTER'S FLOORING AMERICA
 2309 EAST TULARE AVE
 CONTRACTORS LIC # 534223
 TULARE, CA 93274
 Telephone: 559-686-3450 Fax: 559-686-1780

ES813579

QUOTE

Sold To	Ship To
TULARE REGIONAL MEDICAL CENTER 869 N. CHERRY ST. TULARE, CA 93274	TULARE REGIONAL MEDICAL CENTER RECOVERY ROOM TULARE, CA 93274

Quote Date	Tele #1	PO Number	Quote Number
05/30/18	559-688-0821		ES813579

Inventory	Style/Item	Color/Description	Quantity	Units	Price	Extension
JOHNSONITE 6 DC-	JOHNSONITE 6X48X1/8-W/TOE	TO BE CHOSEN	30.00	PC	7.01	210.30
	Id #: JOHNSONITE 6 DC-					
440 ADH	440 30OZ COVE BASE	H-595 440 30 OZ (H-595 30 OZ COVE BASE ADHESIVE	3.00	EA	7.13	21.39
PREVAILING WAGE WEEKDAY	PREV WEEKDAY INSTALL TSB 6"		120.00	LF	1.92	230.40

INSTALL 6" RUBBER COVEBASE IN RECOVERY ROOM

LABOR BASED ON REGULAR WORK DAY HOURS MONDAY-FRIDAY**

— 05/30/18 — 3:35PM —
 Sales Representative(s):
 GREG GIBSON

Sub Total: 462.09
 Sales Tax: 0.00
 Misc. Tax: 0.00



QUOTE TOTAL: \$462.09

COULTER'S FLOORING AMERICA
 2309 EAST TULARE AVE
 CONTRACTORS LIC # 534223
 TULARE, CA 93274
 Telephone: 559-686-3450 Fax: 559-686-1780

ES813580

QUOTE

Sold To	Ship To
TULARE REGIONAL MEDICAL CENTER 869 N. CHERRY ST. TULARE, CA 93274	TULARE REGIONAL MEDICAL CENTER SECTION OF LAB TULARE, CA 93274

Quote Date	Tele #1	PO Number	Quote Number
05/30/18	559-688-0821		ES813580

Inventory	Style/Item	Color/Description	Quantity	Units	Price	Extension
V-82 4G	BIOSPEC FB - 6'6"	TO BE CHOSEN	825.00	SF	4.77	3,935.25
Id #: V-82	V-82 MANN ADHESIVE	V-82 MANN 4 GAL ADHESIVE	2.00	PA	153.28	306.56
1	WELDING RODS	WELD RODS	2.00	EA	54.15	108.30
PREV WEEKDAY	PREV WEEKDAY SCRAPE UP & PREP CARPET		825.00	SF	1.10	907.50
PREV WAGE WKDAY HEAT WELD	PREV WAGE WKDAY HEAT WELD		825.00	LF	1.94	1,600.50
PREV WAGE WKDY VINYL COVING	PREV WAGE WKDY VINYL COVING		141.00	LF	7.02	989.82
PREVAILING WAGE	PREV WEEKDAY INSTALL2"&4" TSB		52.00	LF	1.37	71.24
440 30OZ COVE ADH	440 30OZ COVE BASE	H-595 440 30 OZ (H-595 30 OZ COVE BASE ADHESIVE	1.00	EA	7.13	7.13
JOHNSONITE 4 DC-	JOHNSONITE 4X48X1/8-W/TOE	TO BE CHOSEN	13.00	PC	3.75	48.75
Id #: JOHNSONITE 4 DC-						
VINYL CAP S - COL901S	VINYL CAP S - 1/8 LINO CAP SILV	SILVER	144.00	LF	0.61	87.84
COVE STICK P	COVE STICK PLASTIC	COVE STICK PLASTIC	29.00	EA	2.10	60.90

05/30/18

4:27PM

Sales Representative(s):
 GREG GIBSON

Sub Total: 8,123.79
 Sales Tax: 0.00
 Misc. Tax: 0.00

QUOTE TOTAL: \$8,123.79

COULTER'S FLOORING AMERICA
 2309 EAST TULARE AVE
 CONTRACTORS LIC # 534223
 TULARE, CA 93274
 Telephone: 559-686-3450 Fax: 559-686-1780

ES813580

QUOTE

Sold To	Ship To
TULARE REGIONAL MEDICAL CENTER 869 N. CHERRY ST. TULARE, CA 93274	TULARE REGIONAL MEDICAL CENTER SECTION OF LAB TULARE, CA 93274

Quote Date	Tele #1	PO Number	Quote Number
05/30/18	559-688-0821		ES813580

Inventory	Style/Item	Color/Description	Quantity	Units	Price	Extension
-----------	------------	-------------------	----------	-------	-------	-----------

INSTALL COMMERCIAL HEAT WELD VINYL IN SECTION OF LAB
 VINYL TO BE FULL COVERED IN LAB AREA AND 4" RUBBER COVEBASE
 TO BE INSTALLED IN OFFICE

*****PRICE DOES NOT INCLUDE MOVING OF CONTENTS*****

LABOR BASED ON REGULAR WORK DAY HOURS MONDAY-FRIDAY**

— 05/30/18 —

4:27PM —

Sales Representative(s):
 GREG GIBSON

Sub Total: 8,123.79
 Sales Tax: 0.00
 Misc. Tax: 0.00



QUOTE TOTAL: \$8,123.79

COULTER'S FLOORING AMERICA
 2309 EAST TULARE AVE
 CONTRACTORS LIC # 534223
 TULARE, CA 93274
 Telephone: 559-686-3450 Fax: 559-686-1780

ES813826

QUOTE

Sold To	Ship To
TULARE REGIONAL MEDICAL CENTER 869 N. CHERRY ST. TULARE, CA 93274	TULARE REGIONAL MEDICAL CENTER RX ROOM MED SURG WING TULARE, CA 93274

Quote Date	Tele #1	PO Number	Quote Number
06/29/18	559-688-0821		ES813826

Inventory	Style/Item	Color/Description	Quantity	Units	Price	Extension
AZROCK VCT	AZROCK V SERIES VCT	TO BE CHOSEN	5.00	CTN	55.19	275.95
	Id #: AZROCK VCT TILE					
2033 GAL	2033 VCT ADHESIVE GAL	THINSPREAD ADHESIVE	1.00	EA	22.75	22.75
	Id #: VCT ADHESIVE					
JOHNSONITE 6 DC-	JOHNSONITE 6X48X1/8-W/TOE	TO BE CHOSEN	13.00	PC	7.01	91.13
	Id #: JOHNSONITE 6 DC-					
440 30OZ COVE ADH	440 30OZ COVE BASE	H-595 440 30 OZ (H-595 30 OZ COVE BASE ADHESIVE	2.00	EA	7.13	14.26
DUR9525	9525 WEBCRETE 95 25LB FORTIFIED CEMENT PATCH	WEBCRETE 9525	1.00	EA	23.54	23.54
BOSTIK 425 MULTI-PURPOSE BOSC05	BOSTIK 425 MULTI-PURPOSE ACRYLIC LATEX ADMIXTURE 1 GAL	NONE	1.00	EA	17.76	17.76
326-701	UNDERSLUNG REDUCER	BLACK	1.00	EA	14.05	14.05
	Id #: 326-701					
PREV WAGE VCT SAT PREP	PREV WAGE VCT SAT PREP		3.00	HR	87.62	262.86
PREV WAGE VCT SAT INSTALL	PREV WAGE VCT SAT INSTALL		199.00	SF	2.20	437.80
PREVAILING WAGE SATURDAY	PREV SAT INSTALL TSB 6"		53.00	LF	2.38	126.14

— 07/02/18 — 9:02AM —

Sales Representative(s):
 GREG GIBSON

Sub Total: 1,286.24
 Sales Tax: 0.00
 Misc. Tax: 0.00

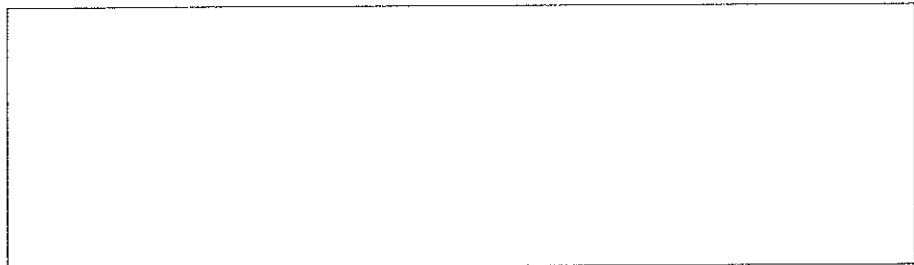

QUOTE TOTAL: \$1,286.24

COULTER'S FLOORING AMERICA
 2309 EAST TULARE AVE
 CONTRACTORS LIC # 534223
 TULARE, CA 93274
 Telephone: 559-686-3450 Fax: 559-686-1780

ES812472

QUOTE

Sold To	Ship To
TULARE REGIONAL MEDICAL CENTER 869 N. CHERRY ST. TULARE, CA 93274	ER REGISTRATION TULARE, CA 93274

Quote Date	Tele #1	PO Number	Quote Number
07/16/18	559-688-0821		ES812472

Inventory	Style/Item	Color/Description	Quantity	Units	Price	Extension
V-82 GAL	CRITERION - STREAMLINE - 6'	CCAPAR205	300.00	SF	6.75	2,025.00
Id #: V-82	V-82 GALLON ADHESIVE	V-82 GALLON ADHESIVE	2.00	GA	41.97	83.94
HEAT WELD	WELDING ROD	TO MATCH	1.00	EA	59.98	59.98
DUR9525	9525 WEBCRETE 95 25LB FORTIFIED	WEBCRETE 9525	1.00	EA	22.88	22.88
	CEMENT PATCH					
VINYL CAP S -	VINYL CAP S - 1/8 LINO CAP SILV	SILVER	72.00	LF	0.52	37.44
COL901S						
COVE STICK P	COVE STICK PLASTIC	COVE STICK PLASTIC	14.00	EA	2.10	29.40
PREV	PREV WEEKDAY SCRAPE UP & PREP		300.00	SF	1.10	330.00
WEEKDAY	CARPET					
SCRAPE UP &						
PREP CARPET						
PREV WAGE	PREV WAGE WKDAY HEAT WELD		300.00	LF	1.94	582.00
WKDAY HEAT						
WELD						
PREV WAGE	PREV WAGE WKDY VINYL COVING		70.00	LF	7.02	491.40
WKDY VINYL						
COVING						

SUPPLY AND INSTALL WOOD PATTERN VINYL IN ER REGISTRATION FULL COVERED

— 07/16/18

9:45AM --

Sales Representative(s):
 GREG GIBSON

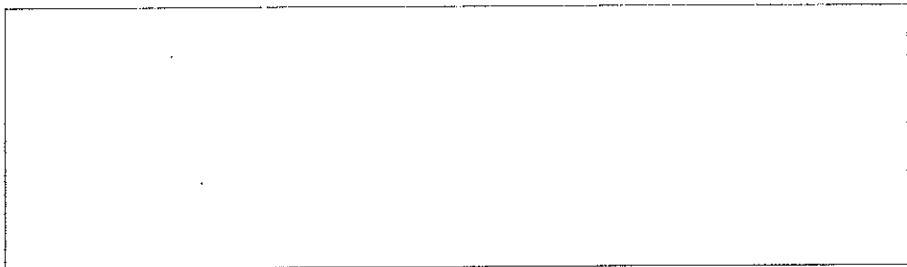

Subtotal: 3,662.04
 Sales Tax: 0.00
 Misc. Tax: 0.00
QUOTE TOTAL: \$3,662.04

COULTER'S FLOORING AMERICA
 2309 EAST TULARE AVE
 CONTRACTORS LIC # 534223
 TULARE, CA 93274
 Telephone: 559-686-3450 Fax: 559-686-1780

ES812475

QUOTE

Sold To TULARE REGIONAL MEDICAL CENTER 869 N. CHERRY ST. TULARE, CA 93274	Ship To ER SECURITY TULARE, CA 93274
---	---

Quote Date 07/16/18	Tele #1 559-688-0821	PO Number	Quote Number ES812475
-------------------------------	--------------------------------	------------------	---------------------------------

Inventory	Style/Item	Color/Description	Quantity Units	Price	Extension
V-82 GAL	BIOSPEC MD - 6'6"	TO BE CHOSEN	33.00 SF	5.89	194.37
Id #: V-82	V-82 GALLON ADHESIVE	V-82 GALLON ADHESIVE	1.00 GA	41.97	41.97
HEAT WELD	WELDING ROD	TO MATCH	1.00 EA	59.98	59.98
DUR9525	9525 WEBCRETE 95 25LB FORTIFIED	WEBCRETE 9525	1.00 EA	22.88	22.88
PREV	CEMENT PATCH				
WEEKDAY	PREV WEEKDAY SCRAPE UP & PREP		33.00 SF	1.10	36.30
SCRAPE UP & PREP CARPET	CARPET				
PREV WAGE	PREV WAGE WKDAY HEAT WELD		33.00 LF	1.94	64.02
WKDAY HEAT WELD					
PREV WAGE REPAIR, HOURLY	PREV WAGE REPAIR, HOURLY		4.00 HR	93.06	372.24
DAP ALMOND	KWIK SEAL ALMOND 5.5	KWIK SEAL ALMOND 5.	1.00 EA	3.90	3.90

PATCH VINYL BEHIND SECURITY DESK AND MISC REPAIRS IN THE SECURITY AREA

— 07/16/18 —

9:47AM —

Sales Representative(s):
 GREG GIBSON

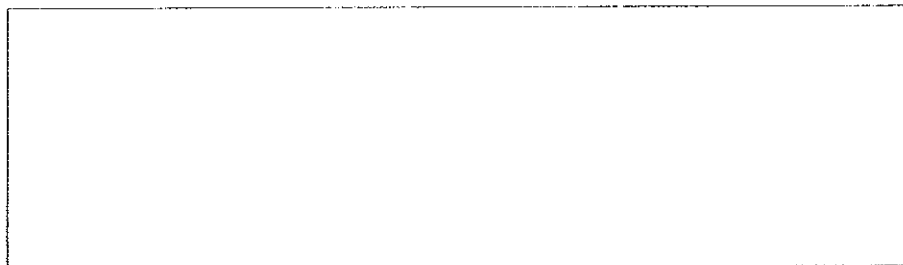

Subtotal: 795.66
 Sales Tax: 0.00
 Misc. Tax: 0.00
QUOTE TOTAL: \$795.66

COULTER'S FLOORING AMERICA
 2309 EAST TULARE AVE
 CONTRACTORS LIC # 534223
 TULARE, CA 93274
 Telephone: 559-686-3450 Fax: 559-686-1780

ES812473

QUOTE

Sold To	Ship To
TULARE REGIONAL MEDICAL CENTER 869 N. CHERRY ST. TULARE, CA 93274	ER BATHROOMS TULARE, CA 93274

Quote Date	Tele #1	PO Number	Quote Number
07/16/18	559-688-0821		ES812473

Inventory	Style/Item	Color/Description	Quantity	Units	Price	Extension
V-82 GAL	BIOSPEC MD - 6"6"	SIERRA	99.00	SF	5.89	583.11
Id #: V-82	V-82 GALLON ADHESIVE	V-82 GALLON ADHESIVE	2.00	GA	41.97	83.94
HEAT WELD	WELDING ROD	TO MATCH	1.00	EA	59.98	59.98
DUR9525	9525 WEBCRETE 95 25LB FORTIFIED CEMENT PATCH	WEBCRETE 9525	1.00	EA	22.88	22.88
VINYL CAP S - COL901S	VINYL CAP S - 1/8 LINO CAP SILV	SILVER	72.00	LF	0.52	37.44
COVE STICK P	COVE STICK PLASTIC	COVE STICK PLASTIC	14.00	EA	2.10	29.40
PREV WEEKDAY SCRAPE UP & PREP CARPET	PREV WEEKDAY SCRAPE UP & PREP CARPET		99.00	SF	1.10	108.90
PREV WAGE WKDAY HEAT WELD	PREV WAGE WKDAY HEAT WELD		99.00	LF	1.94	192.06
PREV WAGE WKDY VINYL COVING	PREV WAGE WKDY VINYL COVING		69.00	LF	7.02	484.38
CLOSET BOLTS 1/4X214	CLOSTE BOLTS 1/4	BRASS	2.00	EA	2.44	4.88
WAX RING W/SLEEVE FLUA02 NO SEEP 1	WAX RING W/SLEEVE FITS 3 INCHES-4 INCHES LINES 7516 NO SEEP 1	WAX RING W/FLANGE 7516 FLEX FLANGE	2.00	EA	2.97	5.94

— 07/16/18 — 9:46AM —

Sales Representative(s):
 GREG GIBSON

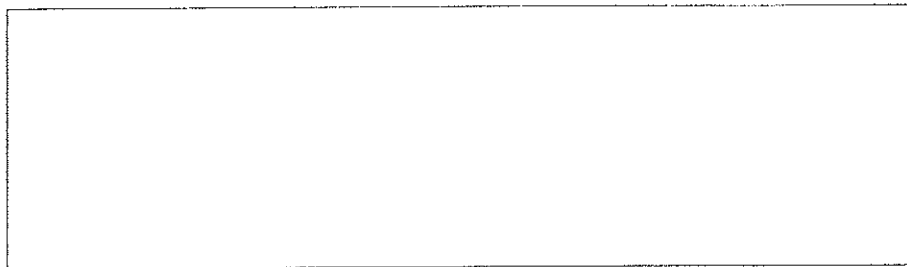

Subtotal: 1,777.89
 Sales Tax: 0.00
 Misc. Tax: 0.00
QUOTE TOTAL: \$1,777.89

COULTER'S FLOORING AMERICA
 2309 EAST TULARE AVE
 CONTRACTORS LIC # 534223
 TULARE, CA 93274
 Telephone: 559-686-3450 Fax: 559-686-1780

ES812473

QUOTE

Sold To TULARE REGIONAL MEDICAL CENTER 869 N. CHERRY ST. TULARE, CA 93274	Ship To ER BATHROOMS TULARE, CA 93274
---	--

Quote Date 07/16/18	Tele #1 559-688-0821	PO Number	Quote Number ES812473
-------------------------------	--------------------------------	------------------	---------------------------------

Inventory	Style/Item	Color/Description	Quantity	Units	Price	Extension
PREV WAGE WKDAY DET AND RESET TOILET	PREV WAGE WKDAY DET AND RESET TOILET		2.00	EACH	82.49	164.98

CUT OUT COVING AND ABOUT 6" OF EXISTING VINYL TO INSTALL NEW ALONG THE PERIMETER OF TWO BATHROOMS

INCLUDES R & R TWO TOILETS

— 07/16/18 —

9:46AM —

Sales Representative(s):
GREG GIBSON

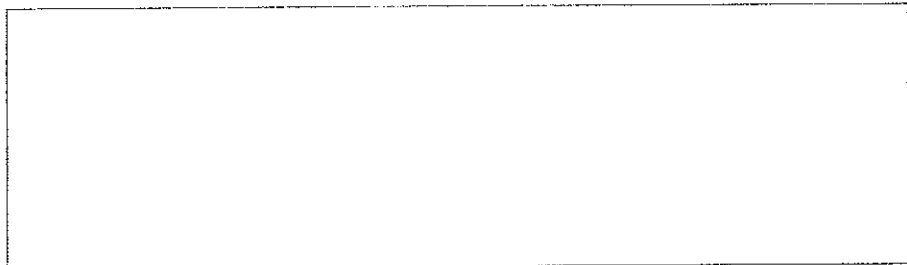

Subtotal: 1,777.89
 Sales Tax: 0.00
 Misc. Tax: 0.00
QUOTE TOTAL: \$1,777.89



4688 W. Jennifer Ave. #101
 Fresno, CA 93722
 Phone: (559) 435-6100
 Fax : (559) 435-6700
 Contractors License# 999046

Proposal

Attn: GEORGE CANTO

From: BILL JOHNSON

Estimator: _____

Admin: BETH VALENTY

Revision #: _____

Date: 5/30/2018

Bid Due Date: 5/30/2018

Plan Date: _____

Addendum : _____

To

TULARE REGIONAL MEDICAL CENTER
 869 N. CHERRY ST.
 TULARE, CA 92374
 Phone: (559) 280-6381-

Project

2ND FLOOR HALLWAY ARMSTRONG TIMBERLINE
 869 CHERRY STREET
 TULARE, CA

PROPOSAL DESCRIPTION

	<i>Manufacturer</i>	<i>Color Name</i>
	<i>Style</i>	<i>Color Number</i>
1	SV-1 SHEET VINYL SUPPLIED AND INSTALLED - PREVAILING WAGE ARMSTRONG WORLD INDUSTRIES, INC. TIMBERLINE REJUVENATIONS	TBD
2	RB-1 WALL BASE SUPPLIED AND INSTALLED - BURKE MERCER ® 6" COVE	TBD

TOTAL (APPLICABLE TAX INCLUDED) \$57,968.00

ADD ALTERNATE TO HIRE AN INDEPENDENT TESTING COMPANY T TEST FOR PH AND RH MOISTURE LEVELS.

	<i>Manufacturer</i>	<i>Color Name</i>
	<i>Style</i>	<i>Color Number</i>
1	MOISTURE TESTING - WAGNER RELATIVE HUMIDITY MOISTURE TESTS	STANDARD

TOTAL (APPLICABLE TAX INCLUDED) \$1,400.00

EXCLUSIONS:

- NO GUARANTEE OF COLOR OR STYLE MATCH TO EXISTING SHEET VINYL.
- NO FURNITURE OR EQUIPMENT MOVING.
- NO REPAIRING OF WALLS.
- NO DEMO INCLUDING OLD ADHESIVES, PAINT AND SHEET ROCK MATERIALS.
- NO CLEAN, WAX POLISH OR BUFFING.
- NO MOISTURE TESTING. (SEE ADD ALTERNATE)
- NO MOISTURE MITIGATION.
- NO PROTECTION OF WORK AFTER INSTALLATION.
- ONLY MINIMAL FLOOR PREP. IS INCLUDED. (ONE COAT OF FEATHER FINISH SKIM COATING ONLY).

**This proposal is valid for forty-five (45) days with approved credit.
Payment is due within ten (10) days of invoice.**

DFS Flooring will furnish all materials and/or labor as described herein and as per attached drawing (where applicable). Price includes all applicable freight and taxes. Customer agrees to provide adequate lighting, power, vertical access and temperature control. Customer is subject to payment for stored materials. DFS flooring will not accept back-charges for trade damage without the option to inspect and correct claims. DFS Flooring is not responsible for any claims or liquidated damages arising from delays caused by material manufacturers. Seam placement of roll goods is subject to manufacturer roll lengths. In any action or proceeding, including an arbitration, between the parties relating to this agreement or to the work, labor and materials furnished to the project or to the project, the prevailing party in any such action or proceeding shall be entitled to recover all attorneys' fees, costs, and expenses incurred therein.

Exclusions: Unless specifically included, this proposal excludes the following items: (1) Major floor preparation consisting of any work beyond typical sweeping, filling of small holes, saw cuts, and shrinkage or expansion cracks in the slab. Examples of major floor preparation include but are not limited to the removal of chemicals, gypsum compound or other foreign substances from the substrate; Any corrective work required to achieve a smooth trowel finish (skim-coating); Any work required to bring the sub-floor to a degree of flatness required by the owner such as floating, leveling, or grinding; Nailing and filling or sanding of irregularities at wood substrates. (2) Moisture testing/ remediation (Per CRI-104-96, 6.3 site conditions: "The owner or general contractor must submit to the flooring contractor a written report on moisture and surface alkalinity of the slab to determine its suitability as a substrate for the material to be installed." DFS Flooring's Installation Warranty does not include any moisture related floor failures. (3) Asbestos control/abatement. (4) Extra material stock beyond floor coverage. (5) Premium labor hours (holidays, weekends, and weekdays from 4PM-5AM). (6) Phasing. (7) Furniture/equipment moving. (8) Premium or custom color selections on unspecified products. (9) Post-installation maintenance including vacuuming; buffing, waxing, sealing, cleaning, and protection.

Nevada Contract Limit \$1,500,000

FRESNO P&I

TULARE REGIONAL MEDICAL CENTER

Signed: _____

Signed: _____

BILL JOHNSON

Proposed Installation Start Date: _____



4688 W. Jennifer Ave. #101
 Fresno, CA 93722
 Phone: (559) 435-6100
 Fax : (559) 435-6700
 Contractors License# 999046

Proposal

Attn: LIONEL MACHADO

From: BILL JOHNSON

Estimator:

Admin: BETH VALENTY

Revision #:

Date: 6/7/2018

Bid Due Date: 6/6/2018

Plan Date:

Addendum :

To

TULARE REGIONAL MEDICAL CENTER
 869 N. CHERRY ST.
 TULARE, CA 92374
 Phone: (559) 303-4651-

Project

TULARE HOSP LAB FLOOR PATCH
 869 CHERRY ST.
 TULARE, CA 92374

PROPOSAL DESCRIPTION

	<i>Manufacturer Style</i>	<i>Color Name Color Number</i>
1	SV-1 SHEET VINYL SUPPLIED AND INSTALLED - PREVAILING WAGE ALTRO RELIANCE 25	TBD
2	FLOOR PREP. - ARDEX FEATHER FINISH	10# BAG

TOTAL (APPLICABLE TAX INCLUDED) \$13,395.00

ADD ALTERNATE TO HIRE AN INDEPENDENT TESTING CO TO TEST THE CONC FOR PH AND RH MOISTURE LEVELS.

	<i>Manufacturer Style</i>	<i>Color Name Color Number</i>
1	MOISTURE TESTING - WAGNER RELATIVE HUMIDITY MOISTURE TESTS	STANDARD

TOTAL (APPLICABLE TAX INCLUDED) \$600.00

DURATION OF THIS JOB IS APPROXIMATLY ONE WEEK.

EXCLUSIONS:

- NO MOVING FURNITURE OR EQUIPMENT.
- NO MOISTURE MITIGATION.
- NO CLEAN, WAX, OLISH OR BUFFING.
- NO PROTECTION OF WORK AFTER INSTALLATION.
- NO MOISTURE TESTING. (SEE ADD ALTERNATE)
- NO CONCRETE GRINDING.
- MINIMAL FLOOR PREP. IS INCLUDED.

This proposal is valid for forty-five (45) days with approved credit.
Payment is due within ten (10) days of invoice.

DFS Flooring will furnish all materials and/or labor as described herein and as per attached drawing (where applicable). Price includes all applicable freight and taxes. Customer agrees to provide adequate lighting, power, vertical access and temperature control. Customer is subject to payment for stored materials. DFS flooring will not accept back-charges for trade damage without the option to inspect and correct claims. DFS Flooring is not responsible for any claims or liquidated damages arising from delays caused by material manufacturers. Seam placement of roll goods is subject to manufacturer roll lengths. In any action or proceeding, including an arbitration, between the parties relating to this agreement or to the work, labor and materials furnished to the project or to the project, the prevailing party in any such action or proceeding shall be entitled to recover all attorneys' fees, costs, and expenses incurred therein.

Exclusions: Unless specifically included, this proposal excludes the following items: (1) Major floor preparation consisting of any work beyond typical sweeping, filling of small holes, saw cuts, and shrinkage or expansion cracks in the slab. Examples of major floor preparation include but are not limited to the removal of chemicals, gypsum compound or other foreign substances from the substrate; Any corrective work required to achieve a smooth trowel finish (skim-coating); Any work required to bring the sub-floor to a degree of flatness required by the owner such as floating, leveling, or grinding; Nailing and filling or sanding of irregularities at wood substrates. (2) Moisture testing/ remediation (Per CRI-104-96, 6.3 site conditions: "The owner or general contractor must submit to the flooring contractor a written report on moisture and surface alkalinity of the slab to determine its suitability as a substrate for the material to be installed." DFS Flooring's Installation Warranty does not include any moisture related floor failures. (3) Asbestos control/abatement. (4) Extra material stock beyond floor coverage. (5) Premium labor hours (holidays, weekends, and weekdays from 4PM-5AM). (6) Phasing. (7) Furniture/equipment moving. (8) Premium or custom color selections on unspecified products. (9) Post-installation maintenance including vacuuming; buffing, waxing, sealing, cleaning, and protection.

Nevada Contract Limit \$1,500,000

FRESNO P&I

TULARE REGIONAL MEDICAL CENTER

Signed:

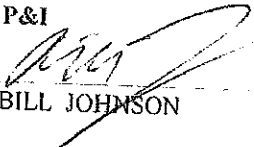
BILL JOHNSON

Signed: _____

Proposed Installation Start Date: _____



4688 W. Jennifer Ave. #101
 Fresno, CA 93722
 Phone: (559) 435-6100
 Fax : (559) 435-6700
 Contractors License# 999046

Proposal

Attn: LIONEL MACHADO

From: BILL JOHNSON

Estimator:

Admin: BETH VALENTY

Revision #:

Date: 6/7/2018

Bid Due Date: 6/6/2018

Plan Date:

Addendum :

To

TULARE REGIONAL MEDICAL CENTER
 869 N. CHERRY ST.
 TULARE, CA 92374
 Phone: (559) 303-4651-

Project

Tulare Med Center ER #1
 869 CHERRY AVE.
 TULARE, CA 92374

PROPOSAL DESCRIPTION

	<i>Manufacturer Style</i>	<i>Color Name Color Number</i>
1 SV-1 SHEET VINYL SUPPLIED AND INSTALLED - PREVAILING WAGE SHANNON SPECIALTY PLANK YOU VERY MUCH 6' SHEET VINYL		TBD
2 FLOOR PREP - PREVAILING WAGHE ARDEX FEATHER FINISH FEATHER FINISH		STANDARD
3 MOISTURE TESTING - WAGNER RELATIVE HUMIDITY MOISTURE TESTS		STANDARD

TOTAL (APPLICABLE TAX INCLUDED) \$25,562.00

ADD ALTERNATE TO INSTALL 4 INCH RUBBER BASE IN RECOVERY ROOM ON SECOND FLOOR

	<i>Manufacturer Style</i>	<i>Color Name Color Number</i>
1 RB-1 WALL BASE SUPPLIED AND INSTALLED - PREVAILING WAGE BURKE MERCER ® 4" COVE		TBD

TOTAL (APPLICABLE TAX INCLUDED) \$320.00

Duration approx two weeks.

- EXCLUSIONS:**
 NO MOISTURE MITIGATION!
 NO MOVING OF FURNITURE OR EQUIPMENT.
 NO CLEAN, WAX, POLISH OR BUFFING.
 NO PROTECTION OF WORK AFTER INSTALLATION.
 NO CONCRETE GRINDING.
 MINIMAL FLOOR PREP. IS INCLUDED.

This proposal is valid for forty-five (45) days with approved credit.
Payment is due within ten (10) days of invoice.

DFS Flooring will furnish all materials and/or labor as described herein and as per attached drawing (where applicable). Price includes all applicable freight and taxes. Customer agrees to provide adequate lighting, power, vertical access and temperature control. Customer is subject to payment for stored materials. DFS flooring will not accept back-charges for trade damage without the option to inspect and correct claims. DFS Flooring is not responsible for any claims or liquidated damages arising from delays caused by material manufacturers. Seam placement of roll goods is subject to manufacturer roll lengths. In any action or proceeding, including an arbitration, between the parties relating to this agreement or to the work, labor and materials furnished to the project or to the project, the prevailing party in any such action or proceeding shall be entitled to recover all attorneys' fees, costs, and expenses incurred therein.

Exclusions: Unless specifically included, this proposal excludes the following items: (1) Major floor preparation consisting of any work beyond typical sweeping, filling of small holes, saw cuts, and shrinkage or expansion cracks in the slab. Examples of major floor preparation include but are not limited to the removal of chemicals, gypsum compound or other foreign substances from the substrate; Any corrective work required to achieve a smooth trowel finish (skim-coating); Any work required to bring the sub-floor to a degree of flatness required by the owner such as floating, leveling, or grinding; Nailing and filling or sanding of irregularities at wood substrates. (2) Moisture testing/ remediation (Per CRI-104-96, 6.3 site conditions: "The owner or general contractor must submit to the flooring contractor a written report on moisture and surface alkalinity of the slab to determine its suitability as a substrate for the material to be installed." DFS Flooring's Installation Warranty does not include any moisture related floor failures. (3) Asbestos control/abatement. (4) Extra material stock beyond floor coverage. (5) Premium labor hours (holidays, weekends, and weekdays from 4PM-5AM). (6) Phasing. (7) Furniture/equipment moving. (8) Premium or custom color selections on unspecified products. (9) Post-installation maintenance including vacuuming; buffing, waxing, sealing, cleaning, and protection.

Nevada Contract Limit \$1,500,000

FRESNO P&I

Signed:

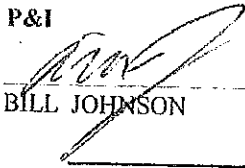
BILL JOHNSON

TULARE REGIONAL MEDICAL CENTER

Signed: _____

Proposed Installation Start Date: _____

Tulare Local Healthcare District dba Tulare Regional Medical Center

Agenda Item

Board Meeting Date: 07-17-18

Title to Appear on Agenda: Fire door inspection and repairs

Brief Description: Hospital Fire doors inspection and repairs

Background and Details: Fire doors within the hospital that meet the intent of life safety, are needing repairs and adjustment. This was noted as of 2017. These need to be corrected to meet NFPA Life Safety 101, and 99.

Sole bid obtained from this vendor (Fire Door Solutions) as not aware of any other functioning companies who do annual fire door inspections.

Fire door repairs-No Fire door replacements-\$28,610 or with Fire door replacement-\$41,905

Exhibits: See attached

Recommended Action: Hospital Board approve Fire Door Solutions to proceed with proposed scope of work delineated in proposals.

Tulare Local Healthcare District dba Tulare Regional Medical Center

Agenda Item

Board Meeting Date: 07-17-18

Title to Appear on Agenda: Fire door inspection and repairs

Brief Description: Hospital Fire doors inspection and repairs

Background and Details: Fire doors are needing repairs and adjustment. This was noted as of last year. These need to be corrected to meet NFPA Life Safety 101, and 99.

Exhibits: See attached

Recommended Action: Hospital Board approve Fire Door Solutions to proceed with proposed scope of work delineated in proposal.

RE: 2017 Fire Door Repairs - Phase II Options

Lionel Machado

Wed 4/11/2018 9:25 AM

To: 'Zach Bartolich' <zbartolich@firedoorsolutions.com>; Sandra Gomez <sgomez@tulareregional.org>;

Zach due to our current status, we will need to opt to go with door compliance with repairs (No door replacements). Please let me know how you would like to proceed regarding payment. Once I hear from you, I will discuss with administration.

Thanks,

Lionel

From: Zach Bartolich [<mailto:zbartolich@firedoorsolutions.com>]

Sent: Tuesday, April 10, 2018 4:23 PM

To: Sandra Gomez <sgomez@tulareregional.org>

Cc: Lionel Machado <lmachado@tulareregional.org>

Subject: 2017 Fire Door Repairs - Phase II Options

Hi Sandra and Lionel,

Attached are the final fire door compliance repair quotes from last year. There is one option that includes door replacements and one without us doing the door replacements. Below is a breakdown of the cost, please contact me with any concerns or questions.

NO DOOR REPLACEMENTS:

Tulare Regional Medical Center

\$14,008 – Hardware purchase, (4) Closers, (3) Filler Plate, (1) Continuous Hinge, (3) Ball Bearing Hinges, (7) Exit Devices, (2) Strikes, (4) Glazing/Louver, (4) Undercuts, (6) NGP 9200, (1) Fire Crown Products

\$2,900 – Replace 9 fire door and 15 frame labels

\$6,864 – Labor

\$4,838 – Travel

\$28,610 – Total

WITH DOOR REPLACEMENTS:

Tulare Regional Medical Center

\$20,703 – Hardware purchase, (5) Adjustments, (4) Closers, (3) Filler Plate, (1) Continuous Hinge, (18) Ball Bearing Hinges, (7) Exit Devices, (2) Strikes, (4) Glazing/Louver, (5) Metal Doors, (4) Undercuts, (6) NGP 9200, (1) Fire Crown Products

4/11/2018

\$2,900 – Replace 9 fire door and 15 frame labels

\$11,814 – Labor

\$6,488 – Travel

\$41,905 – Total

Once again, we'll have discuss payment terms before we proceed with the work. We look forward to assisting you with this need.

Thank you,

Zach Bartolich

Regional Account Director - Southwest

Fire Door Solutions

(913) 563-4773(Direct)

(855) 714-FIRE (3473)

7500 W 160th Street

Stilwell, KS 66085

zbartolich@firedoorsolutions.com

www.firedoorsolutions.com

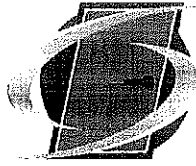

Fire Door Solutions

Compliance Made Easy®

7500 W 160th Street Stilwell, Kansas 66085 855-714-3473 www.FireDoorSolutions.com

Fire Door Compliance Phase II Agreement

This is a Life Safety Inspection Agreement dated April 10, 2018 by and between Fire Door Solutions LLC, 7500 W 160th Street, Stilwell, KS 66085 and Tulare Regional Medical Center, located at 869 N Cherry St, Tulare, CA 93274.

Attn: Lionel Machado

The Parties agree on the following:

1. SERVICES: Fire Door Solutions LLC will:

1. Provide repairs on non-compliant fire rated doors from the deficiencies reports. Upon completion of the second phase of the repairs all of the deficiencies noted on the fire door inspections report will be compliant.
2. Provide a report of all repairs completed.
3. The per man hour fee will be \$120.00 per hour plus any materials required to perform the fire door repairs, plus any travel, accommodations or per diem expenses incurred as quoted. The final repair project will not exceed \$28,610.00.
4. Pricing quoted above does not include sales tax. Sales tax will be charged on each service and product, where applicable, unless Owner provides a sales tax exemption certificate to Fire Door Solutions.
5. All pricing and service estimates are based on validated life safety plans.

2. PAYMENT:

The Owner shall pay Fire Door Solutions LLC for the labor to be performed and expenses incurred under the Agreement.

Payable in full prior to completion of job.

Please provide:

Accounts Payable Contact _____

Accounts Payable Email _____

Accounts Payable Phone # _____

3. GENERAL PROVISIONS:

1. All work shall be completed in a professional manner, in compliance with all building, Joint Commission and NFPA codes and standards.
2. All work shall be performed by individuals trained and authorized by law.
3. Fire Door Solutions LLC warrants that it is insured for injury to its employees and others incurring loss or injury as a result of the acts of Fire Door Solutions LLC or its employees in the amount of \$1,000,000.00 per incident.
4. Fire Door Solutions LLC is an independent contractor and not an employee of Facility.
5. Any changes to this document must be in writing and signed by both Fire Door Solutions LLC and Facility Representative.
6. The start date for the work set forth in this agreement shall be established by mutual consent between the Facility Representative and Operations Division, Fire Door Solutions LLC Corporate Headquarters.

****Containment to be used in the OR, ICU, & CCU, or as required by the facility. ****

4. The full agreement of the parties is expressed herein this contract and no understandings, agreements, purchase orders, or other documents shall modify this agreement unless expressly agreed to, in writing, signed by both parties.

5. Facility understands that Fire Door Solutions LLC is not an insurance provider and does not guarantee facility against loss caused by fire damage. The parties agree that Fire Door Solutions LLC does not and cannot warrant that the services will prevent loss in the event of a fire. Fire

Door Solutions LLC responsibility is solely limited to providing inspection and/or repair services. Their service shall not give rise to or confer any rights on any third party, and the facility agrees to indemnify/ defend and hold harmless Fire Door Solutions LLC against any claims by third parties to include but not limited to the fees and court costs.

It is understood and agreed that in no event will Fire Door Solutions LLC be liable to the facility or any other party for direct, indirect, consequential special damages, punitive damage and lost profits resulting from the services provided herein. It is further understood and agreed that in no event shall Fire Door Solutions LLC be held liable for any damages in excess of the amount paid by the facility to Fire Door Solutions LLC.

6. Fire Door Solutions shall inform the client, in advance, of the information it intends to place in the public domain. Except for information that the client makes publicly available, or when agreed between the inspection body and the client (e.g. for the purpose of responding to complaints), all other information is considered proprietary information and shall be regarded as confidential.

7. Fire Door Solutions LLC is an Equal Opportunity Employer and does not discriminate on the basis of race, creed, sex, age, marital status or national origin and complies with all known pertinent laws.

Facility Representative

Signature

(Please print name)

Title

PO# (if applicable)

Fire Door Solutions LLC

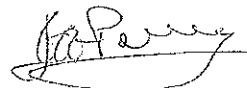

Signature

Jeff Perry

Executive Director
Fire Door Solutions LLC
Phone: 913-563-4777

Fax: 913-273-0554
Email: JPerry@FireDoorSolutions.com

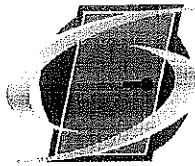

Fire Door Solutions

Compliance Made Easy®

7500 W 160th Street Stilwell, Kansas 66085 855-714-3473 www.FireDoorSolutions.com

Fire Door Compliance Phase II Agreement

This is a Life Safety Inspection Agreement dated April 10, 2018 by and between Fire Door Solutions LLC, 7500 W 160th Street, Stilwell, KS 66085 and Tulare Regional Medical Center, located at 869 N Cherry St, Tulare, CA 93274.

Attn: Lionel Machado

The Parties agree on the following:

1. SERVICES: Fire Door Solutions LLC will:

1. Provide repairs on non-compliant fire rated doors from the deficiencies reports. Upon completion of the second phase of the repairs all of the deficiencies noted on the fire door inspections report will be compliant.
2. Provide a report of all repairs completed.
3. The per man hour fee will be \$120.00 per hour plus any materials required to perform the fire door repairs, plus any travel, accommodations or per diem expenses incurred as quoted. The final repair project will not exceed \$41,905.00.
4. Pricing quoted above does not include sales tax. Sales tax will be charged on each service and product, where applicable, unless Owner provides a sales tax exemption certificate to Fire Door Solutions.
5. All pricing and service estimates are based on validated life safety plans.

2. PAYMENT:

The Owner shall pay Fire Door Solutions LLC for the labor to be performed and expenses incurred under the Agreement.

Payable in full prior to completion of job.

Please provide:

Accounts Payable Contact _____

Accounts Payable Email _____

Accounts Payable Phone # _____

3. GENERAL PROVISIONS:

1. All work shall be completed in a professional manner, in compliance with all building, Joint Commission and NFPA codes and standards.
2. All work shall be performed by individuals trained and authorized by law.
3. Fire Door Solutions LLC warrants that it is insured for injury to its employees and others incurring loss or injury as a result of the acts of Fire Door Solutions LLC or its employees in the amount of \$1,000,000.00 per incident.
4. Fire Door Solutions LLC is an independent contractor and not an employee of Facility.
5. Any changes to this document must be in writing and signed by both Fire Door Solutions LLC and Facility Representative.
6. The start date for the work set forth in this agreement shall be established by mutual consent between the Facility Representative and Operations Division, Fire Door Solutions LLC Corporate Headquarters.

****Containment to be used in the OR, ICU, & CCU, or as required by the facility. ****

4. The full agreement of the parties is expressed herein this contract and no understandings, agreements, purchase orders, or other documents shall modify this agreement unless expressly agreed to, in writing, signed by both parties.

5. Facility understands that Fire Door Solutions LLC is not an insurance provider and does not guarantee facility against loss caused by fire damage. The parties agree that Fire Door Solutions LLC does not and cannot warrant that the services will prevent loss in the event of a fire. Fire

Door Solutions LLC responsibility is solely limited to providing inspection and/or repair services. Their service shall not give rise to or confer any rights on any third party, and the facility agrees to indemnify/ defend and hold harmless Fire Door Solutions LLC against any claims by third parties to include but not limited to the fees and court costs.

It is understood and agreed that in no event will Fire Door Solutions LLC be liable to the facility or any other party for direct, indirect, consequential special damages, punitive damage and lost profits resulting from the services provided herein. It is further understood and agreed that in no event shall Fire Door Solutions LLC be held liable for any damages in excess of the amount paid by the facility to Fire Door Solutions LLC.

6. Fire Door Solutions shall inform the client, in advance, of the information it intends to place in the public domain. Except for information that the client makes publicly available, or when agreed between the inspection body and the client (e.g. for the purpose of responding to complaints), all other information is considered proprietary information and shall be regarded as confidential.

7. Fire Door Solutions LLC is an Equal Opportunity Employer and does not discriminate on the basis of race, creed, sex, age, marital status or national origin and complies with all known pertinent laws.

Facility Representative

Signature

(Please print name)

Title

PO# (if applicable)

Fire Door Solutions LLC

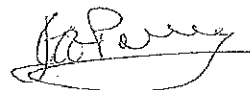

Signature

Jeff Perry

Executive Director
Fire Door Solutions LLC
Phone: 913-563-4777

Fax: 913-273-0554
Email: JPerry@FireDoorSolutions.com

Tulare Local Healthcare District dba Tulare Regional Medical Center

Agenda Item

Board Meeting Date: 07-17-18

Title to Appear on Agenda: OR Line Isolation Monitor (LIM) repair/replacement

Brief Description: Line Isolation monitor provides both visual and audible alarm signals to alert medical staff of the presence of a line to ground fault on connected equipment. System status are displayed on a LCD screens

Background and Details: The current LIM is very aged and was noted to continually fail when tested. This needs to be corrected. This will most likely be an OSHPD issue as well and possible abatement. This needs to be corrected to meet NFPA 99 and NFPA 101

Only able to located a single vendor for the work needed. Other Vendors contacted unable to carry out scope of work required.

Line Isolation repair/replacement-\$40,635

Exhibits: See attached

Recommended Action: Hospital Board approve Wild Electric to proceed with proposed scope of work delineated in proposal.



LICENSE NO. 500696

4626 EAST OLIVE AVENUE
FRESNO, CA 93702
PHONE - (559) 251-7770 - FAX - (559) 251-2372
Email - fmerlo@wildelectric.net

June 25, 2018

Mr. Lionel Machado
Tulare Regional Hospital
869 N. Cherry Street
Tulare, Ca 93274

Project: Operating Suites -- LIM System Malfunctioning
Subject: Revised Bid Price

Mr. Machado,

Wild Electric is pleased to submit a bid price to provide the electrical work for the installation of Three (3) new LIM systems for the Operating Rooms. The following is the scope of work.

1. The power to the LIM system will be disconnected and the existing module will be removed.
2. The door where the LIM module is located will be modified to accept the new module.
3. The module will be installed and connected to the Connector Plate and the 120-volt power.
4. In the operating suite, after the wall is opened by others the new room annunciator will be installed and connected to the existing annunciator box.
5. The existing conductors that are installed between the LIM module and the existing annunciator will be connected to the module. At the existing annunciator box, the existing conductors will be extended to the new annunciator and terminated.
6. The system will be tested.
7. All work will be performed during normal working hours.
8. All wall opening, patch and painting will be by others.
9. OSHPD drawings will be furnished. Drawings to be submitted by others.

Total Bid Price: \$40,635.00

Sincerely,
Wild Electric, Inc.

Fred Merlo

Fred Merlo
BID: F18-060B

Installation and Connection

3.2.9 Wiring Diagram: LIM2010 and MK2000

This remote provides a SAFE LED, a HAZARD LED, and a mute button / LED.

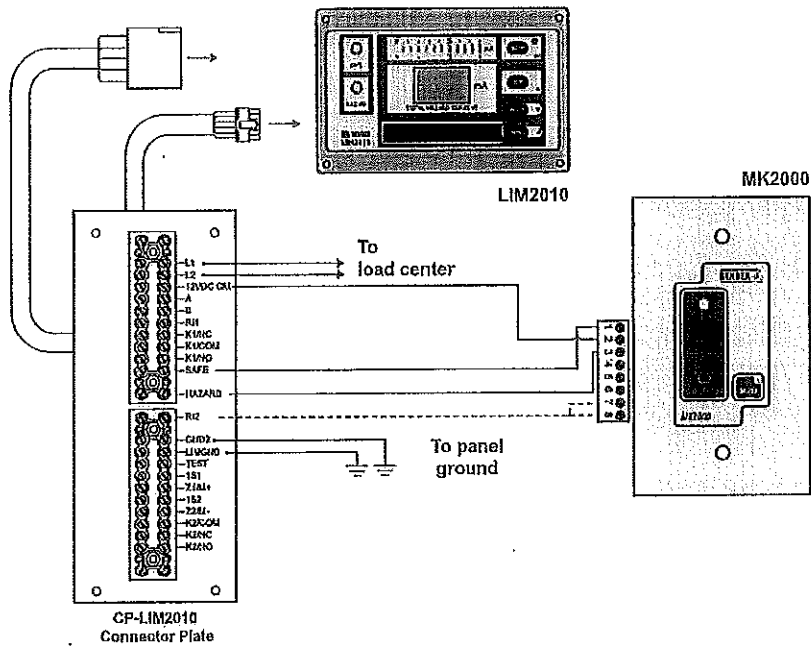

Connection Notes:

- Connector plate L1 and L2 connect to the main system conductors.
- Connector plate LIMGND and GND2 are SEPARATE connections to the system ground.
- Connector plate Safe, Hazard, and 12 VDC COM connect to the respective terminals on the remote.
- Connector plate R12 connection is required for system muting.

Tulare Local Healthcare District dba Tulare Regional Medical Center

Agenda Item

Board Meeting Date: 07-17-18

Title to Appear on Agenda: Elevator repairs and ADA upgrades

Brief Description: Elevators are in need of repairs and ADA compliance upgrades

Background and Details: We have a total of 6 elevators and some of them are in need of repair, maintenance and upgrades. Some of the elevators are requiring ADA conformance which is currently missing.

The hospital has a service agreement in place with Thyssenkrupp. No other bids obtained due to this.

Repairs-\$31,435-quote needs to be revised minus the switchboxes to reflect appropriate scope of repairs needed. Switchbox repairs are already scheduled and monies allocated for repairs.

Solid State Starters-\$24,170

ADA phone/Door Edge-\$6,664

Exhibits: See attached

Recommended Action: Hospital Board approve Thyssenkrupp to proceed with proposed scope of work delineated in proposals.



WORK ORDER

Date: April 20, 2018

Recommended by: Miller, Glenn

Purchaser: Tulare Regional Medical Center

Location: TULARE DISTRICT HOSPITAL

Address: 869 N Cherry St

869 N Cherry St

City/State/Zip: Tulare, CA 93274-2207

Tulare, CA 93274-2207

Purchaser authorizes thyssenkrupp Elevator Corporation (referred to as "thyssenkrupp Elevator" hereafter) to perform the following work on the equipment and at the location described above, in exchange for the sum of **Thirty One Thousand Four Hundred Thirty Five Dollars (\$31,435.00)** plus any applicable tax pursuant to the terms and conditions contained in this Work Order (the "Work Order").

Scope of Work:

ThyssenKrupp Elevator will provide labor and material to complete the following work:

Elevator 2&3:

- Install two earthquake seismic switch boxes
- Replace pick up and hanger rollers

Elevator 6:

- Install new victaulic fittings.

Elevator 7:

- Replace the valve and add oil

Sidewalk:

- Clean down of the hoistway

Annex:

- Replace door pick up rollers

No permits or inspections by others are included in this work, unless otherwise indicated herein. Delivery and shipping is included. All work is to be performed during regular working days and hours as defined in this Work Order unless otherwise indicated herein.

Terms and Conditions

thyssenkrupp Elevator does not assume any responsibility for any part of the vertical transportation equipment other than the specific components that are described in this Work Order and then only to the extent thyssenkrupp Elevator has performed the work described above.

No work, service, examination or liability on the part of thyssenkrupp Elevator is intended, implied or included other than the work specifically described above. It is agreed that thyssenkrupp Elevator does not assume possession or control of any part of the vertical transportation equipment and that such remains Purchaser's exclusively as the owner, lessor, lessee, possessor, or manager thereof.

Unless otherwise stated herein, thyssenkrupp Elevator's performance of this Work Order is expressly contingent upon Purchaser securing permission or priority as required by all applicable governmental agencies and paying for any and all applicable permits or other similar documents.

It is agreed that thyssenkrupp Elevator's personnel shall be given a safe place in which to work. thyssenkrupp Elevator reserves the right to discontinue its work in the location above whenever, in its sole opinion, thyssenkrupp Elevator believes that any aspect of the location is in any way unsafe until such time as Purchaser has demonstrated, at its sole expense, that it has appropriately remedied the unsafe condition to thyssenkrupp Elevator's satisfaction. Unless otherwise



WORK ORDER



Recommended by:KARL RESSLER

Date: December 19, 2016

Location: TULARE REGIONAL MEDICAL CENTER

Bill To: Tulare Regional Medical Center

Address: 869 N Cherry St

Address: 869 N Cherry St

City/State/Zip: Tulare , CA 93274-2207

City/State/Zip: Tulare , CA 93274-2207

Scope of Work:

Purchaser authorizes ThyssenKrupp Elevator Corporation to perform the following described work on the following vertical transportation equipment in the above building:

ThyssenKrupp Elevator will provide labor and material to install five (5) new solid state starters at above location.

Solid State Starter

Our Solid State Starter incorporates the latest technology to provide precise control of the starting and stopping of any AC induction motor. They are simple to operate, troubleshoot, repair, and, best of all, lower operating costs. Benefits include: Advanced motor up-to-speed sensing shortens the transition time between floors. Absolute control over starting current-maximizes motor protection and longevity. Conventional contacts/coils are unnecessary and motor life is extended. Phase loss protection removes damaging power to the motor when problems with utility lines result in single phasing. Solid state reduced voltage starting allows the motor voltage to be gradually applied, reducing the equipment's impact on peak current draw and potentially damaging high inrush currents and starting torque. In a conventional system the generator continues to idle when an elevator has come to rest at a floor with the doors closed. Since the Solid State starter is capable of limiting current on initial start and does not produce any significant voltage spikes which damage the motor. When the generator is disconnected from power, it is no longer consuming power and is, therefore, saving money! Return on investment is typically between 1.5 to 2 years. By using the formula below we can calculate the dollar savings: (Idle Power Time (hrs/week)) X (power usage of the generator (kW/hr.)) X (52 weeks/year) X (\$/kW) = \$ Saved/Year.

Purchaser agrees to pay the sum of: Twenty Four Thousand One Hundred Seventy Dollars (\$24,170.00) plus any applicable sales tax billed in addition to this contract price. Price includes shipping and delivery and sales/use tax imposed on TKEC but does not include sales or gross receipts tax that may be billed in addition to the contract price. No permits or inspections by others are included in this work, unless otherwise indicated herein.



Terms and Conditions:

ThyssenKrupp Elevator does not assume any responsibility for any part of the vertical transportation equipment other than the specific components that are described in this Work Order and then only to the extent ThyssenKrupp Elevator has performed the work described above. No work, service, examination or liability on the part of ThyssenKrupp Elevator is intended, implied or included other than the work specifically described above.

It is agreed that ThyssenKrupp Elevator does not assume possession or control of any part of the vertical transportation equipment and that such remains Purchaser's exclusively as the owner, lessor, lessee, possessor, or manager thereof.

Unless otherwise stated herein, ThyssenKrupp Elevator's performance of this Work Order is expressly contingent upon Purchaser securing permission or priority as required by all applicable governmental agencies and paying for any and all applicable permits or other similar documents.

It is agreed that ThyssenKrupp Elevator's personnel shall be given a safe place in which to work. ThyssenKrupp Elevator reserves the right to discontinue its work in the location above whenever, in its sole opinion, ThyssenKrupp Elevator believes that any aspect of the location is in any way unsafe until such time as Purchaser has demonstrated, at its sole expense, that it has appropriately remedied the unsafe condition to thyssenkrupp Elevator's satisfaction.

Unless otherwise agreed, it is understood that the work described above will be performed during regular working hours of the trades involved which are defined as Monday through Friday, 7.30 AM to 4.30 PM (except scheduled union holidays). If overtime is mutually agreed upon, an additional charge at ThyssenKrupp Elevator's usual rates for such work shall be added to the price of this Work Order.

In consideration of ThyssenKrupp Elevator performing the work described above Purchaser, to the fullest extent permitted by law, expressly agrees to indemnify, defend, save harmless, discharge, release and forever acquit ThyssenKrupp Elevator, its employees, officers, agents, affiliates, and subsidiaries from and against any and all claims, demands, suits, and proceedings made or brought against ThyssenKrupp Elevator, its employees, officers, agents, affiliates and subsidiaries for loss, property damage (including damage to the equipment which is the subject matter of this Work Order), personal injury or death that are alleged to have been caused by Purchaser or any others in connection with the presence, use, misuse, maintenance, installation, removal, manufacture, design, operation or condition of the vertical transportation equipment that is the subject of this Work Order, or the associated areas surrounding such equipment. Purchaser's duty to indemnify does not apply to the extent that the loss, property damage (including damage to the equipment which is the subject matter of this Work Order), personal injury or death is determined to be caused by or resulting from the negligence of ThyssenKrupp Elevator and/or its employees. Purchaser recognizes, however, that its obligation to defend ThyssenKrupp Elevator and its employees, officers, agents, affiliates and subsidiaries under this clause is broader and distinct from its duty to indemnify and specifically includes payment of all attorney's fees, court costs, interest and any other expenses of litigation arising out of such claims or lawsuits.

ThyssenKrupp Elevator's performance of this Work Order is contingent upon Purchaser furnishing ThyssenKrupp Elevator with any necessary permission or priority required under the terms and conditions of any and all government regulations affecting the acceptance of this Work Order or the manufacture, delivery or installation of any equipment described in this Work Order. Purchaser shall bear all cost(s) for any re-inspection of ThyssenKrupp Elevator's work due to items outside the scope of this Work Order or for any inspection arising from the work of other trades requiring the assistance of ThyssenKrupp Elevator. If any drawings, illustrations or other descriptive materials were furnished in conjunction with this Work Order, they were intended solely as approximations and to illustrate the general style and arrangement of equipment being offered and should, under no circumstances, be relied upon for their accuracy. Unless otherwise agreed, it is understood that the work described above will be performed during regular working hours of the trades involved. If overtime is mutually agreed upon, an additional charge at ThyssenKrupp Elevator's usual rates for such work shall be added to the price of this Work Order.



In consideration of ThyssenKrupp Elevator performing the services herein specified, Purchaser, to the fullest extent permitted by law, expressly agrees to indemnify, defend, save harmless, discharge, release and forever acquit ThyssenKrupp Elevator Corporation, ThyssenKrupp Elevator Manufacturing, Inc., their respective employees, officers, agents, affiliates, and subsidiaries from and against any and all claims, demands, suits, and proceedings for loss, property damage (including damage to the equipment which is the subject matter of this Work Order), personal injury or death that are alleged to have arisen out of the presence, use, misuse, maintenance, installation, removal, repair, replacement, modernization, manufacture, design, operation or condition of the equipment that is the subject matter of this Work Order or any equipment located underground, in the elevator car/cab, in the elevator machine room and/or in the hoistways of the project location. Purchaser's duty to indemnify does not apply to the extent that the loss, property damage (including damage to the equipment which is the subject matter of this Work Order), personal injury or death is determined to be caused by or resulting from the sole negligence of ThyssenKrupp Elevator and/or its employees. Purchaser recognizes that its obligation to ThyssenKrupp Elevator under this clause includes payment of all attorneys' fees, court costs, judgements, settlements, interest and any other expenses of litigation arising out of such claims, demands, suits or proceedings.

Purchaser further expressly agrees to name ThyssenKrupp Elevator Corporation and ThyssenKrupp Elevator Manufacturing, Inc. along with their respective officers, agents, affiliates and subsidiaries as additional insureds in Purchaser's liability and any excess (umbrella) liability insurance policy(ies). Such insurance must insure the above-referenced additional insureds for those claims and/or losses referenced in the above paragraph, and for claims and/or losses arising from the additional insureds' sole negligence or responsibility. Such insurance must specify that its coverage is primary and non-contributory. Purchaser hereby waives its right of subrogation.

By executing this Work Order, Purchaser agrees that in no event shall ThyssenKrupp Elevator be liable for any consequential, indirect, incidental, exemplary, special or liquidated damages of any type or kind under any circumstances including any loss, damage, or delay caused by acts of government, labor troubles, strikes, lockouts, fire, explosion, theft, floods, riot, civil commotion, war, malicious mischief, acts of God or any cause beyond its control. ThyssenKrupp Elevator shall automatically receive an extension of time commensurate with any delay regarding the aforementioned. Should loss of or damage to ThyssenKrupp Elevator's material, tools or work occur at the location that is the subject of this Work Order, Purchaser shall compensate ThyssenKrupp Elevator therefore, unless such loss or damage results solely from ThyssenKrupp Elevator's own acts or omissions.

Purchaser agrees that all existing equipment removed by ThyssenKrupp Elevator in the performance of the work described above shall become the exclusive property of ThyssenKrupp Elevator. ThyssenKrupp Elevator retains title to all equipment supplied by ThyssenKrupp Elevator under this Work Order and a security interest therein, (which, it is agreed, can be removed without material injury to the real property) until all payments under the terms of both this Work Order and any mutually agreed to-change orders have been made. In the event Purchaser fails to meet any of its obligations under this Work Order, Purchaser authorizes ThyssenKrupp Elevator to take immediate possession of the equipment installed under this Work Order and enter upon the premises where it is located (without legal process) and remove such equipment or portions thereof irrespective of the manner of its attachment to the real estate or the sale, mortgage, or lease of the real estate. Pursuant to the Uniform Commercial Code, at ThyssenKrupp Elevator's request, Purchaser agrees to join with ThyssenKrupp Elevator in executing any financial or continuation statements which may be appropriate for ThyssenKrupp Elevator to file in public offices in order to perfect its security interest in such equipment.

In the event a third party is retained to enforce, construe or defend any of the terms and conditions of this Work Order or to collect any monies due hereunder, either with or without litigation, the prevailing party shall be entitled to recover all costs and reasonable attorney's fees. Purchaser agrees that this Work Order shall be construed and enforced in accordance with the laws of the state where the vertical transportation equipment that is the subject of this Work Order is located and consents to jurisdiction of the courts, both state and Federal, of that as to all matters and disputes arising out of this Work Order. Purchaser further agrees to waive trial by jury for all such matters and disputes.



The rights of ThyssenKrupp Elevator under this Work Order shall be cumulative and the failure on the part of the ThyssenKrupp Elevator to exercise any rights given hereunder shall not operate to forfeit or waive any of said rights and any extension, indulgence or change by ThyssenKrupp Elevator in the method, mode or manner of payment or any of its other rights shall not be construed as a waiver of any of its rights under this Work Order. In the event any portion of this Work Order is deemed invalid or unenforceable by a court of law, such finding shall not affect the validity or enforceability of any other portion of this Work Order. This Work Order shall be considered as having been drafted jointly by Purchaser and ThyssenKrupp Elevator and shall not be construed or interpreted against either Purchaser or ThyssenKrupp Elevator by reason of either Purchaser or ThyssenKrupp Elevator's role in drafting same.

ThyssenKrupp Elevator does not assume any responsibility for any part of the vertical transportation equipment other than the specific components that are described in this Work Order and then only to the extent ThyssenKrupp Elevator has performed the work described above. ThyssenKrupp Elevator has made no examination of, and assumes no responsibility for, any part of the elevator equipment except that necessary to do the work described above. It is agreed that possession and control of the vertical transportation equipment remains Purchaser's exclusively as the owner, lessor, lessee, possessor, or manager thereof.

ThyssenKrupp Elevator complies with provisions of Executive Orders 11246, 11375, 11758, Section 503 of the Rehabilitation Act of 1993, Vietnam Era Veteran's Readjustment Act of 1974, 38 U.S.C. 4212 and 41 CFR Chapter 60. ThyssenKrupp Elevator supports Equal Employment Opportunity and Affirmative Actions Compliance programs.

ThyssenKrupp Elevator Americas



Unless otherwise stated, you agree to pay as follows: 50% upon signed acceptance and 50% upon completion.

To indicate acceptance of this work order, please sign and return one (1) original of this agreement to the address shown below. Upon receipt of your written authorization and required materials and/or supplies, we shall implement the work order.

This Work Order is submitted for acceptance within 30 days from the date executed by ThyssenKrupp Elevator Corporation.

Purchaser's acceptance of this Work Order together with the terms and conditions printed on subsequent pages hereof and which are expressly made a part of this proposal and agreed to, will constitute exclusively and entirely the agreement for the work herein described. All prior representations or agreements regarding this work, whether written or verbal, will be deemed to be merged herein, and no other changes in or additions to this agreement will be recognized unless made in writing and properly executed by both parties. This Work Order specifically contemplates work outside the scope of any maintenance contract currently in effect between the parties; any such contract shall be unaffected by this Work Order.

No agent or employee shall have the authority to waive or modify any of the terms of this agreement without the written approval of an authorized ThyssenKrupp Elevator Corporation manager.

ThyssenKrupp Elevator Corporation	Tulare Regional Medical Center	ThyssenKrupp Elevator Corporation Approval
By: _____ (Signature of ThyssenKrupp Elevator Representative)	By: _____ (Signature of Authorized Individual)	By: _____ (Signature of Authorized Individual)
Maarit Grajeda Account Manager maarit.grajeda@thyssenkrupp.com +1 December 19, 2016 _____ (Date Submitted)	Thomas Walburn _____ (Print or Type Name) _____ (Print or Type Title) _____ (Date of Approval)	Paul Taormina Branch Manager _____ (Date of Approval)

ThyssenKrupp Elevator Americas



**SCHEDULING AND PRODUCTION
REQUEST FOR PAYMENT**

Contract Number:

Please Remit To: thyssenkrupp Elevator Corporation
PO Box 933004
Atlanta, GA 31193-3004

Attn:

Tulare Regional Medical Center
869 N Cherry St
Tulare , CA 93274-2207

Terms	Repair Quote No.	Customer Reference No./PO	Date	Reference Number
Immediate	2016-2-306915		December 19, 2016	ACIA-17RUGL7

Total Contract Price \$24,170.00
Current Amount Due \$12,085.00

For inquiries regarding your contract or services provided by thyssenkrupp Elevator, please contact your local account manager at +1. To make a payment by phone using your check or credit card, please call 801-449-8270 with the reference information provided below.

Thank you for choosing thyssenkrupp Elevator Corporation. We appreciate your business.

Please detach the below section and provide along with payment.

Remit To:

thyssenkrupp Elevator Corporation
PO Box 933004
Atlanta, GA 31193-3004

Customer Number:	138872
Payment Reference Number:	ACIA-17RUGL7
Quote Number:	2016-2-306915
Remittance Amount:	\$12,085.00

Customer Name: Tulare Regional Medical Center
Location Name: TULARE REGIONAL MEDICAL CENTER



thyssenkrupp

WORK ORDER

Date: April 04, 2018

Purchaser: Tulare Regional Medical Center
Address: 869 N Cherry St
City/State/Zip: Tulare, CA 93274-2207

Location: TULARE REGIONAL MEDICAL CENTER
869 N Cherry St
Tulare, CA 93274-2207

Purchaser authorizes thyssenkrupp Elevator Corporation (referred to as "thyssenkrupp Elevator" hereafter) to perform the following work on the equipment and at the location described above, in exchange for the sum of **Six Thousand Six Hundred Sixty Four Dollars (\$6,664.00)** plus any applicable tax pursuant to the terms and conditions contained in this Work Order (the "Work Order").

Scope of Work:

ADA Phone

thyssenkrupp Elevator will furnish and install an ADA compliant, autodial telephone in the elevator cab control panel for the building/elevators referenced above. Telephone Requirements (Work by Others/Owner): It is the owners responsibility to provide a dedicated telephone line (installed if necessary) to the elevator controller in the machine room. Please have the line installed from the telephone distribution center to the machine room terminating above the controller with at least 5 feet of extra telephone line.

Door Edge

thyssenkrupp Elevator will furnish and install one new electronic door edge on the elevator at the above location to replace the existing mechanical safety edge. This electronic edge senses the presence of an obstruction in the door opening with a screen of infrared beams. If obstructions are detected in this area, the doors will reopen. This new electronic door edge will reduce the chance of a closing elevator door injuring passengers.

No permits or inspections by others are included in this work, unless otherwise indicated herein. Delivery and shipping is included. All work is to be performed during regular working days and hours as defined in this Work Order unless otherwise indicated herein.

Terms and Conditions

thyssenkrupp Elevator does not assume any responsibility for any part of the vertical transportation equipment other than the specific components that are described in this Work Order and then only to the extent thyssenkrupp Elevator has performed the work described above.

No work, service, examination or liability on the part of thyssenkrupp Elevator is intended, implied or included other than the work specifically described above. It is agreed that thyssenkrupp Elevator does not assume possession or control of any part of the vertical transportation equipment and that such remains Purchaser's exclusively as the owner, lessor, lessee, possessor, or manager thereof.

Unless otherwise stated herein, thyssenkrupp Elevator's performance of this Work Order is expressly contingent upon Purchaser securing permission or priority as required by all applicable governmental agencies and paying for any and all applicable permits or other similar documents.

It is agreed that thyssenkrupp Elevator's personnel shall be given a safe place in which to work. thyssenkrupp Elevator reserves the right to discontinue its work in the location above whenever, in its sole opinion, thyssenkrupp Elevator believes that any aspect of the location is in any way unsafe until such time as Purchaser has demonstrated, at its sole expense, that it has appropriately remedied the unsafe condition to thyssenkrupp Elevator's satisfaction. Unless otherwise agreed, it is understood that the work described above will be performed during regular working days and hours which are defined as Monday through Friday, 8:00 AM to 4:30 PM (except scheduled union holidays). If overtime is mutually agreed upon, an additional charge at thyssenkrupp Elevator's usual rates for such work shall be added to the price of this Work Order.



thyssenkrupp

In consideration of thyssenkrupp Elevator performing the work described above Purchaser, to the fullest extent permitted by law, expressly agrees to indemnify, defend, save harmless, discharge, release and forever acquit thyssenkrupp Elevator, its employees, officers, agents, affiliates, and subsidiaries from and against any and all claims, demands, suits, and proceedings made or brought against thyssenkrupp Elevator, its employees, officers, agents, affiliates and subsidiaries for loss, property damage (including damage to the equipment which is the subject matter of this Work Order), personal injury or death that are alleged to have been caused by Purchaser or any others in connection with the presence, use, misuse, maintenance, installation, removal, manufacture, design, operation or condition of the vertical transportation equipment that is the subject of this Work Order, or the associated areas surrounding such equipment. Purchaser's duty to indemnify does not apply to the extent that the loss, property damage (including damage to the equipment which is the subject matter of this Work Order), personal injury or death is determined to be caused by or resulting from the negligence of thyssenkrupp Elevator and/or its employees. Purchaser recognizes, however, that its obligation to defend thyssenkrupp Elevator and its employees, officers, agents, affiliates and subsidiaries under this clause is broader and distinct from its duty to indemnify and specifically includes payment of all attorney's fees, court costs, interest and any other expenses of litigation arising out of such claims or lawsuits.

Purchaser expressly agrees to name thyssenkrupp Elevator along with its officers, agents, affiliates and subsidiaries as additional insureds in Purchaser's liability and any excess (umbrella) liability insurance policy(ies). Such insurance must insure thyssenkrupp Elevator, along with its officers, agents, affiliates and subsidiaries for those claims and/or losses referenced in the above paragraph, and for claims and/or losses arising from the negligence or legal responsibility of thyssenkrupp Elevator and/or its officers, agents, affiliates and subsidiaries. Such insurance must specify that its coverage is primary and non-contributory. Purchaser hereby waives the right of subrogation.

thyssenkrupp Elevator shall not be liable for any loss, damage or delay caused by acts of government, labor, troubles, strikes, lockouts, fire, explosions, theft, riot, civil commotion, war, malicious mischief, acts of God, or any cause beyond its control. thyssenkrupp Elevator Corporation shall automatically receive an extension of time commensurate with any delay regarding the work called for in this Work Order.

Should loss of or damage to thyssenkrupp Elevator's material, tools or work occur at the location that is the subject of this Work Order, Purchaser shall compensate thyssenkrupp Elevator therefor, unless such loss or damage results solely from thyssenkrupp Elevator's own acts or omissions.

If any drawings, illustrations or descriptive matter are furnished with this Work Order, they are approximate and are submitted only to show the general style and arrangement of equipment being offered. Work Order.

Purchaser shall bear all cost(s) for any reinspection of thyssenkrupp Elevator's work due to items outside the scope of this Work Order or for any inspection arising from the work of other trades requiring the assistance of thyssenkrupp Elevator.

Purchaser expressly agrees to waive any and all claims for consequential, special or indirect damages arising out of the performance of this Work Order and specifically releases thyssenkrupp Elevator from any and all such claims.

A service charge of 1.5% per month, or the highest legal rate, whichever is less, shall apply to delinquent accounts. In the event of any default of any of the payment provisions herein, Purchaser agrees to pay, in addition to any defaulted amount, any attorney fees, court costs and all other expenses, fees and costs incurred by thyssenkrupp Elevator in connection with the collection of that defaulted amount.

Purchaser agrees that this Work Order shall be construed and enforced in accordance with the laws of the state where the vertical transportation equipment that is the subject of this Work Order is located and consents to jurisdiction of the courts, both state and Federal, of that as to all matters and disputes arising out of this Work Order. Purchaser further agrees to waive trial by jury for all such matters and disputes.

The rights of thyssenkrupp Elevator under this Work Order shall be cumulative and the failure on the part of the thyssenkrupp Elevator to exercise any rights given hereunder shall not operate to forfeit or waive any of said rights and any extension, indulgence or change by thyssenkrupp Elevator in the method, mode or manner of payment or any of its other rights shall not be construed as a waiver of any of its rights under this Work Order.

In the event any portion of this Work Order is deemed invalid or unenforceable by a court of law, such finding shall not affect the validity or enforceability of any other portion of this Work Order.

This Work Order shall be considered as having been drafted jointly by Purchaser and thyssenkrupp Elevator and shall not be construed or interpreted against either Purchaser or thyssenkrupp Elevator by reason of either Purchaser or thyssenkrupp Elevator's role in drafting same.



thyssenkrupp

In the event Purchaser's acceptance of the work called for in this Work Order is in the form of a purchase order or other kind of document, the provisions, terms and conditions of this Work Order shall exclusively govern the relationship between thyssenkrupp Elevator and Purchaser with respect to the work described herein.



thyssenkrupp

Acceptance

This Work Order is submitted for acceptance within 30 days from the date executed by thyssenkrupp Elevator. Unless otherwise stated, the Purchaser agrees to pay as follows: 50% upon signed acceptance of this Work Order and \$3,332.00 upon completion of the work described in this Work Order.

Purchaser's acceptance of this Work Order will constitute exclusively and entirely the agreement for the work herein described. All prior representations or agreements regarding this work, whether written or verbal, will be deemed to be merged herein, and no other changes in or additions to this Work Order will be recognized unless made in writing and properly executed by both parties. No agent or employee of thyssenkrupp Elevator shall have the authority to waive or modify any of the terms of this Work Order without the written approval of an authorized thyssenkrupp Elevator manager. This Work Order specifically contemplates work outside the scope of any other contract currently in effect between the parties; any such contract shall be unaffected by this Work Order.

To indicate acceptance of this work order, please sign and return one (1) original of this agreement to the address shown below. Upon receipt of your written authorization and required materials and/or supplies, we shall implement the work called for in this Work Order.

thyssenkrupp Elevator Corporation:	Tulare Regional Medical Center (PURCHASER):
<p>By: _____ (Signature of thyssenkrupp Elevator Representative)</p> <p>Maarit Grajeda Account Manager maarit.grajeda@thyssenkrupp.com +1</p> <p>04-04-2018 _____ (Date of Submission)</p>	<p>By: _____ (Signature of Authorized Individual)</p> <p>Thomas Walburn _____ (Print or Type Name)</p> <p>_____ (Print or Type Title)</p> <p>_____ (Date of Acceptance)</p>
thyssenkrupp Elevator Corporation Approval	
<p>_____ (Date of Approval)</p> <p>_____ (Signature of Branch Representative)</p> <p>Paul Taormina Branch Manager</p>	



thyssenkrupp

**SCHEDULING AND PRODUCTION
REQUEST FOR PAYMENT**

Please Remit To: thyssenkrupp Elevator Corporation
PO Box 933004
Atlanta, GA 31193-3004

Attn: Thomas Walburn
Tulare Regional Medical Center
869 N Cherry St
Tulare CA, 93274-2207

Date	Terms	Reference ID	Customer Reference # / PO
April 04, 2018	Immediate	ACIA-17VD50W	

Total Contract Price:	\$6,664.00
Down Payment:	(50%) \$3,332.00
Amount Due upon Acceptance:	\$3,332.00

For inquiries regarding your contract or services provided by thyssenkrupp Elevator, please contact your local account manager at +1. To make a payment by phone, please call 801-449-8270 with the reference information provided below.

Thank you for choosing thyssenkrupp Elevator. We appreciate your business.

Please detach the below section and provide along with payment.

Customer Name: Tulare Regional Medical Center
Location Name: TULARE REGIONAL MEDICAL CENTER
Customer Number: 138872

Remit To:
thyssenkrupp Elevator Corporation
PO Box 933004
Atlanta GA 31193-3004

Reference ID:	ACIA-17VD50W
Remittance Amount:	\$3,332.00

Tulare Local Healthcare District dba Tulare Regional Medical Center

Agenda Item

Board Meeting Date: 07-17-18

Title to Appear on Agenda: Recommendation for Fire Detection System for Information Technology (IT) Server Room

Brief Description: Lack of Fire detection system in the IT server room

Background and Details: The IT server room is lacking any Fire detection system. The IT server room is the networking system for the facility as a whole. This is a recommendation noted by the Hospital insurance carrier. This item is a life safety component.

Sole bid provided as the hospital has a standing agreement with Johnson Control
Fire detection install-\$6,308

Exhibits: See attached

Recommended Action: Hospital Board approve Johnson Controls to proceed with proposed scope of work delineated in proposal.



2788 N Larkin Ave
 Ste 101
 FRESNO, CA 93727-1315
 (559) 348 0614
 FAX: (559) 348 1281

Johnson Controls Quotation

TO:
 Tulare Regional Medical Center
 869 N Cherry St
 TULARE, CA 93274-2287

Project: New Quote
 Customer Reference:
 Johnson Controls Reference: 413417345
 Date: 06/07/2018
 Page 1 of 4

Johnson Controls is pleased to offer for your consideration this quotation for the above project.

Comments

Provide materials, labor, wiring, programming, drawings and submittals to add three (3) smoke detectors to the existing FireLite System. Remove existing sprinkler head if allowable by the Authority Having Jurisdiction.

ITEMS PROVIDED BY OTHERS: 120VAC, Existing as build drawings, AutoCad Background Drawings for server room

QUANTITY	MODEL NUMBER	DESCRIPTION
New System		
New Material List		
1	DPFA	DP FIRE ALARM
1	DPMLZ	INSTALLATION MOBILIZATION
1	TECH LAB	TECHNICAL LABOR
4	PM LAB	PROJECT/CONSTRUCTION MGMT
4	DSGN LAB	DESIGN LABOR
4	CAD LAB	CAD LABOR

Total net selling price, FOB shipping point, \$6,308.00

TERMS AND CONDITIONS (Rev. 4/18)

1. **Payment.** Payments shall be invoiced and due in accordance with the terms and conditions set forth above. Work performed on a time and material basis shall be at Company's then-prevailing rate for material, labor, and related items, in effect at the time supplied under this Agreement. Company shall invoice Customer for progress payments to one hundred (100%) percent based upon equipment delivered or stored, and services performed. Customers without established satisfactory credit shall make payments of cash in advance, upon delivery or as otherwise specified by Company. Where Customer establishes and maintains satisfactory credit, payments shall be due and payable thirty (30) days from date of invoice. Company reserves the right to revoke or modify Customer's credit in its sole discretion. Customer's failure to make payment when due is a material breach of this Agreement. If Customer fails to make any payment when due, in addition to any other rights and remedies available, Company shall have the right, at Company's sole discretion, to stop performing any Services and/or withhold further deliveries of materials, until the account is current. In the event payment is not received when due, Company may, at its discretion, assess late fees at the rate of 1.5% per month or the maximum rate allowed by law. Customer agrees to pay all costs of collection, including without limitation costs, fees, and attorneys' fees. Customer's failure to make payment when due is a material breach of this Agreement until the account is current.

2. **Pricing.** The pricing set forth in this Agreement is based on the number of devices to be installed and services to be performed as set forth in the Scope of Work ("Equipment" and "Services"). If the actual number of devices installed or services to be performed is greater than that set forth in the Scope of Work, the price will be increased accordingly. If this Agreement extends beyond one year, Company may increase prices upon notice to the Customer. Customer agrees to pay all taxes, permits, and other charges, including but not limited to state and local sales and excise taxes, however designated, levied or based on the service charges pursuant to this Agreement. Prices in any quotation or proposal from Company are subject to change upon notice sent to Customer at any time before the quotation or proposal has been accepted. Prices for products covered may be adjusted by Company, upon notice to Customer at any time prior to shipment, to reflect any increase in Company's cost of raw materials (e.g., steel, aluminum) incurred by Company after issuance of Company's applicable proposal or quotation.

3. **Alarm Monitoring Services.** Any reference to alarm monitoring services in this Agreement is included for pricing purposes only. Alarm monitoring services are performed pursuant to the terms and conditions of Company's standard alarm monitoring services agreement.

4. **Code Compliance.** Company does not undertake an obligation to inspect for compliance with laws or regulations unless specifically stated in the Scope of Work. Customer acknowledges that the Authority Having Jurisdiction (e.g. Fire Marshal) may establish additional requirements for compliance with local codes. Any additional services or equipment required will be provided at an additional cost to Customer.

5. **Limitation of Liability; Limitations of Remedy.** It is understood and agreed by the Customer that Company is not an insurer and that insurance coverage shall be obtained by the Customer and that amounts payable to company hereunder are based upon the value of the services and the scope of liability set forth in this Agreement and are unrelated to the value of the Customer's property and the property of others located on the premises. Customer agrees to look exclusively to the Customer's insurer to recover for injuries or damage in the event of any loss or injury and that Customer releases and waives all right of recovery against Company arising by way

of subrogation. Company makes no guaranty or Warranty, including any implied warranty of merchantability or fitness for a particular purpose that equipment or services supplied by Company will detect or avert occurrences or the consequences therefrom that the equipment or service was designed to detect or avert. It is impractical and extremely difficult to fix the actual damages, if any, which may proximately result from failure on the part of Company to perform any of its obligations under this Agreement. Accordingly, Customer agrees that, Company shall be exempt from liability for any loss, damage or injury arising directly or indirectly from occurrences, or the consequences therefrom, which the equipment or service was designed to detect or avert. Should Company be found liable for any loss, damage or injury arising from a failure of the equipment or service in any respect, Company's liability shall be limited to an amount equal to the Agreement price (as increased by the price for any additional work) or where the time and material payment term is selected, Customer's time and material payments to Company. Where this Agreement covers multiple sites, liability shall be limited to the amount of the payments allocable to the site where the incident occurred. Such sum shall be complete and exclusive. **IN NO EVENT SHALL COMPANY BE LIABLE FOR ANY DAMAGE, LOSS, INJURY, OR ANY OTHER CLAIM ARISING FROM ANY SERVICING, ALTERATIONS, MODIFICATIONS, CHANGES, OR MOVEMENTS OF THE COVERED SYSTEM(S) OR ANY OF ITS COMPONENT PARTS BY THE CUSTOMER OR ANY THIRD PARTY. COMPANY SHALL NOT BE LIABLE FOR INDIRECT, INCIDENTAL OR CONSEQUENTIAL DAMAGES OF ANY KIND, INCLUDING BUT NOT LIMITED TO DAMAGES ARISING FROM THE USE, LOSS OF THE USE, PERFORMANCE, OR FAILURE OF THE COVERED SYSTEM(S) TO PERFORM.** The limitations of liability set forth in this Agreement shall inure to the benefit of all parents, subsidiaries and affiliates of company, whether direct or indirect, company's employees, agents, officers and directors.

6. **Reciprocal Waiver of Claims (SAFETY Act).** Certain of Company's systems and services have received Certification and/or Designation as Qualified Anti-Terrorism Technologies ("QATT") under the Support Anti-terrorism by Fostering Effective Technologies Act of 2002, 6 U.S.C. §§ 441-444 (the "SAFETY Act"). As required under 6 C.F.R. 25.5 (e), to the maximum extent permitted by law, Company and Customer hereby agree to waive their right to make any claims against the other for any losses, including business interruption losses, sustained by either party or their respective employees, resulting from an activity resulting from an "Act of Terrorism" as defined in 6 C.F.R. 25.2, when QATT have been deployed in defense against, response to, or recovery from such Act of Terrorism.

7. **General Provisions.** Customer has selected the service level desired after considering and balancing various levels of protection afforded, and their related costs. All work to be performed by Company will be performed during normal working hours of normal working days (8:00 a.m. - 5:00 p.m., Monday through Friday, excluding Company holidays), as defined by Company, unless additional times are specifically described in this Agreement. Company will perform the services described in the Scope of Work section ("Services") for one or more system(s) or equipment as described in the Scope of Work section or the listed attachments ("Covered System(s)"). The Customer shall promptly notify Company of any malfunction in the Covered System(s) which comes to Customer's attention. This Agreement assumes the Covered System(s) are in operational and maintainable condition as of the Agreement date. If, upon initial inspection, Company determines that repairs are recommended, repair charges will be submitted for

approval prior to any work. Should such repair work be declined Company shall be relieved from any and all liability arising therefrom. **UNLESS OTHERWISE SPECIFIED IN THIS AGREEMENT, ANY INSPECTION (AND, IF SPECIFIED, TESTING) PROVIDED UNDER THIS AGREEMENT DOES NOT INCLUDE ANY MAINTENANCE, REPAIRS, ALTERATIONS, REPLACEMENT OF PARTS, OR ANY FIELD ADJUSTMENTS WHATSOEVER, NOR DOES IT INCLUDE THE CORRECTION OF ANY DEFICIENCIES IDENTIFIED BY COMPANY TO CUSTOMER. COMPANY SHALL NOT BE RESPONSIBLE FOR EQUIPMENT FAILURE OCCURRING WHILE COMPANY IS IN THE PROCESS OF FOLLOWING ITS INSPECTION TECHNIQUES, WHERE THE FAILURE ALSO RESULTS FROM THE AGE OR OBSOLESCENCE OF THE ITEM OR DUE TO NORMAL WEAR AND TEAR. THIS AGREEMENT DOES NOT COVER SYSTEMS, EQUIPMENT, COMPONENTS OR PARTS THAT ARE BELOW GRADE, BEHIND WALLS OR OTHER OBSTRUCTIONS OR EXTERIOR TO THE BUILDING, ELECTRICAL WIRING, AND PIPING.**

8. **Customer Responsibilities.** Customer shall furnish all necessary facilities for performance of its work by Company, adequate space for storage and handling of materials, light, water, heat, heat tracing, electrical service, local telephone, watchman, and crane and elevator service and necessary permits. Where wet pipe system is installed, Customer shall supply and maintain sufficient heat to prevent freezing of the system. Customer shall promptly notify Company of any malfunction in the Covered System(s) which comes to Customer's attention. This Agreement assumes any existing system(s) are in operational and maintainable condition as of the Agreement date. If, upon initial inspection, Company determines that repairs are recommended, repair charges will be submitted for approval prior to any work. Should such repair work be declined Company shall be relieved from any and all liability arising therefrom. Customer shall further:

- supply required schematics and drawings unless they are to be supplied by Company in accordance with this Agreement;
- Provide a safe work environment, in the event of an emergency or Covered System(s) failure, take reasonable safety precautions to protect against personal injury, death, and property damage, continue such measures until the Covered System(s) are operational, and notify Company as soon as possible under the circumstances.
- Provide Company access to any system(s) to be serviced,
- Comply with all laws, codes, and regulations pertaining to the equipment and/or services provided under this agreement.

9. **Excavation.** In the event the Work includes excavation, Customer shall pay, as an extra to the contract price, the cost of any additional work performed by Company dues to water, quicksand, rock or other unforeseen condition or obstruction encountered or shoring required.

10. **Structure and Site Conditions.** While employees of Company will exercise reasonable care in this respect, Company shall be under not responsibility for loss or damage due to the character, condition or use of foundations, walls, or other structures not erected by it or resulting from the excavation in proximity thereto, or for damage resulting from concealed piping, wiring, fixtures, or other equipment or condition of water pressure. All shoring or protection of foundation, walls or other structures subject to being disturbed by any excavation required hereunder shall be the responsibility of Customer. Customer shall have all things in readiness for installation including, without limitation, structure to support the sprinkler system and related equipment (including tanks), other materials, floor or suitable working base, connections and facilities for erection at the time the materials are delivered. In the event Customer fails to have all things in readiness at the time scheduled for receipt of materials, Customer shall reimburse Company for all expenses caused by such failure. Failure to make areas

available to Company during performance in accordance with schedules that are the basis for Company's proposal shall be considered a failure to have things in readiness in accordance with the terms of this Agreement.

11. Confined Space. If access to confined space by Company is required for the performance of Services, Services shall be scheduled and performed in accordance with Company's then-current hourly rate.

12. Hazardous Materials. Customer represents that, except to the extent that Company has been given written notice of the following hazards prior to the execution of this Agreement, to the best of Customer's knowledge there is no:

- "permit confined space," as defined by OSHA,
- risk of infectious disease,
- need for air monitoring, respiratory protection, or other medical risk,
- asbestos, asbestos-containing material, formaldehyde or other potentially toxic or otherwise hazardous material contained in or on the surface of the floors, walls, ceilings, insulation or other structural components of the area of any building where work is required to be performed under this Agreement.

All of the above are hereinafter referred to as "Hazardous Conditions". Company shall have the right to rely on the representations listed above. If hazardous conditions are encountered by Company during the course of Company's work, the discovery of such materials shall constitute an event beyond Company's control and Company shall have no obligation to further perform in the area where the hazardous conditions exist until the area has been made safe by Customer as certified in writing by an independent testing agency, and Customer shall pay disruption expenses and re-mobilization expenses as determined by Company. This Agreement does not provide for the cost of capture, containment or disposal of any hazardous waste materials, or hazardous materials, encountered in any of the Covered System(s) and/or during performance of the Services. Said materials shall at all times remain the responsibility and property of Customer. Company shall not be responsible for the testing, removal or disposal of such hazardous materials.

13. OSHA Compliance. Customer shall indemnify and hold Company harmless from and against any and all claims, demands and/or damages arising in whole or in part from the enforcement of the Occupational Safety Health Act (and any amendments or changes thereto) unless said claims, demands or damages are a direct result of causes within the exclusive control of Company.

14. Interferences. Customer shall be responsible to coordinate the work of other trades (including but not limited to ducting, piping, and electrical) and for and additional costs incurred by Company arising out of interferences to Company's work caused by other trades.

15. Modifications and Substitutions. Company reserves the right to modify materials, including substituting materials of later design, providing that such modifications or substitutions will not materially affect the performance of the Covered System(s).

16. Changes, Alterations, Additions. Changes, alterations and additions to the Scope of Work, plans, specifications or construction schedule shall be invalid unless approved in writing by Company. Should changes be approved by Company, that increase or decrease the cost of the work to Company, the parties shall agree, in writing, to the change in price prior to performance of any work. However, if no agreement is reached prior to the time for performance of said work, and Company elects to perform said work so as to avoid delays, then Company's estimate as to the value of said work shall be deemed accepted by Customer. In addition, Customer shall pay for all extra work requested by Customer or made necessary because of incompleteness or inaccuracy of plans or other information submitted by Customer with respect to the location, type of occupancy, or other details of the work to be performed. In the event the layout of Customer's facilities has been altered, or is altered by Customer prior to the completion of the Work,

Customer shall advise Company, and prices, delivery and completion dates shall be changed by Company as may be required.

17. Commodities Availability. Company shall not be responsible for failure to provide services, deliver products, or otherwise perform work required by this Agreement due to lack of available steel products or products made from plastics or other commodities. In the event Company is unable, after reasonable commercial efforts, to acquire and provide steel products, or products made from plastics or other commodities, if required to perform work required by this Agreement, Customer hereby agrees that Company may terminate the Agreement, or the relevant portion of the Agreement, at no additional cost and without penalty. Customer agrees to pay Company in full for all work performed up to the time of any such termination.

18. Project Claims. Any claim of failure to perform against Company arising hereunder shall be deemed waived unless received by Company, in writing specifically setting forth the basis for such claim, within ten (10) days after such claims arises.

19. Backcharges. No charges shall be levied against Company unless seventy-two (72) hours prior written notice is given to Company to correct any alleged deficiencies which are alleged to necessitate such charges and unless such alleged deficiencies are solely and directly caused by Company.

20. System Equipment. The purchase of equipment or peripheral devices (including but not limited to smoke detectors, passive infrared detectors, card readers, sprinkler system components, extinguishers and hoses) from Company shall be subject to the terms and conditions of this Agreement. If, in Company's sole judgment, any peripheral device or other system equipment, which is attached to the Covered System(s), whether provided by Company or a third party, interferes with the proper operation of the Covered System(s), Customer shall remove or replace such device or equipment promptly upon notice from Company. Failure of Customer to remove or replace the device shall constitute a material breach of this Agreement. If Customer adds any third party device or equipment to the Covered System(s), Company shall not be responsible for any damage to or failure of the Covered System(s) caused in whole or in part by such device or equipment.

21. Reports. Where inspection and/or test services are selected, such inspection and/or test shall be completed on Company's then current Report form, which shall be given to Customer, and, where applicable, Company may submit a copy thereof to the local authority having jurisdiction. The Report and recommendations by Company are only advisory in nature and are intended to assist Customer in reducing the risk of loss to property by indicating obvious defects or impairments noted to the system and equipment inspected and/or tested. They are not intended to imply that no other defects or hazards exist or that all aspects of the Covered System(s), equipment, and components are under control at the time of inspection. Final responsibility for the condition and operation of the Covered System(s) and equipment and components lies with Customer.

22. Limited Warranty. Subject to the limitations below, Company warrants any equipment (as distinguished from the Software) installed pursuant to this Agreement to be free from defects in material and workmanship under normal use for a period of one (1) year from the date of first beneficial use or all or any part of the Covered System(s) or 18 months after Equipment shipments, whichever is earlier, provided however, that Company's sole liability, and Customer's sole remedy, under this limited warranty shall be limited to the repair or replacement of the Equipment or any part thereof, which Company determines is defective, at Company's sole option and subject to the availability of service personnel and parts, as determined by Company. Company warrants expendable items, including, but not limited to, video and print heads, television camera tubes, video monitor displays tubes, batteries and certain other products in accordance with the applicable manufacturer's warranty. Company does not warrant devices designed to fail in

protecting the System, such as, but not limited to, fuses and circuit breakers. Company warrants that any Company software described in this Agreement, as well as software contained in or sold as part of any Equipment described in this Agreement, will reasonably conform to its published specifications in effect at the time of delivery and for ninety (90) days after delivery. However, Customer agrees and acknowledges that the software may have inherent defects because of its complexity. Company's sole obligation with respect to software, and Customer's sole remedy, shall be to make available published modifications, designed to correct inherent defects, which become available during the warranty period. If Repair Services are included in this Agreement, Company warrants that its workmanship and material for repairs made pursuant to this Agreement will be free from defects for a period of ninety (90) days from the date of furnishing.

EXCEPT AS EXPRESSLY SET FORTH HEREIN, COMPANY DISCLAIMS ALL WARRANTIES, EXPRESS OR IMPLIED, INCLUDING BUT NOT LIMITED TO ANY IMPLIED WARRANTIES OF MERCHANTABILITY OR FITNESS FOR A PARTICULAR PURPOSE WITH RESPECT TO THE SERVICES PERFORMED OR THE PRODUCTS, SYSTEMS OR EQUIPMENT, IF ANY, SUPPORTED HEREUNDER.

Warranty service will be performed during Company's normal working hours. If Customer requests warranty service at other than normal working hours, service will be performed at Company's then current rates for after hours services. All repairs or adjustments that are or may become necessary shall be performed by and authorized representative of Company. Any repairs, adjustments or interconnections performed by Customer or any third party shall void all warranties.

23. Indemnity. Customer agrees to indemnify, hold harmless and defend Company against any and all losses, damages, costs, including expert fees and costs, and expenses including reasonable defense costs, arising from any and all third party claims for personal injury, death, property damage or economic loss, including specifically any damages resulting from the exposure of workers to Hazardous Conditions whether or not Customer pre-notifies Company of the existence of said hazardous conditions, arising in any way from any act or omission of Customer or Company relating in any way to this Agreement, including but not limited to the Services under this Agreement, whether such claims are based upon contract, warranty, tort (including but not limited to active or passive negligence), strict liability or otherwise. Company reserves the right to select counsel to represent it in any such action.

24. Insurance. Customer shall name Company, its officers, employees, agents, subcontractors, suppliers, and representatives as additional insureds on Customer's general liability and auto liability policies.

25. Termination. Any termination under the terms of this Agreement shall be made in writing. In the event Customer terminates this Agreement prior to completion for any reason not arising solely from Company's performance or failure to perform, Customer understands and agrees that Company will incur costs of administration and preparation that are difficult to estimate or determine. Accordingly, should Customer terminate this Agreement as described above, Customer agrees to pay all charges incurred for products and equipment installed and services performed, and in addition pay an amount equal to twenty (20%) percent of the price of products and equipment not yet delivered and Services not yet performed, return all products and equipment delivered and pay a restocking fee of twenty (20%) percent of the price of products or equipment returned. Company may terminate this Agreement immediately at its sole discretion upon the occurrence of any Event of Default as hereinafter defined. Company may also terminate this Agreement at its sole discretion upon notice to Customer if Company's performance of its obligations under this Agreement becomes impracticable due to obsolescence of equipment at Customer's premises or unavailability of parts.

26. Default. An Event of Default shall be 1) failure of the Customer to pay any amount within ten (10) days after the



amount is due and payable, 2) abuse of the System or the Equipment, 3) dissolution, termination, discontinuance, insolvency or business failure of Customer. Upon the occurrence of an Event of Default, Company may pursue one or more of the following remedies, 1) discontinue furnishing Services, 2) by written notice to Customer declare the balance of unpaid amounts due and to become due under the this Agreement to be immediately due and payable, provided that all past due amounts shall bear interest at the rate of 1 1/2% per month (18% per year) or the highest amount permitted by law, 3) receive immediate possession of any equipment for which Customer has not paid. 4) proceed at law or equity to enforce performance by Customer or recover damages for breach of this Agreement, and 5) recover all costs and expenses, including without limitation reasonable attorneys' fees, in connection with enforcing or attempting to enforce this Agreement.

27. Exclusions. Unless expressly included in the Scope of Work, this Agreement expressly excludes, without limitation, testing inspection and repair of duct detectors, beam detectors, and UV/IR equipment; provision of fire watches; clearing of ice blockage; draining of improperly pitched piping; replacement of batteries; recharging of chemical suppression systems; reloading of, upgrading, and maintaining computer software; system upgrades and the replacement of obsolete systems, equipment, components or parts; making repairs or replacements necessitated by reason of negligence or misuse of components or equipment or changes to Customer's premises, vandalism, corrosion (including but not limited to micro-bacterially induced corrosion ("MIC")); power failure, current fluctuation, failure due to non-Company installation, lightning, electrical storm, or other severe weather, water, accident, fire, acts of God or any other cause external to the Covered System(s). Repair Services provided pursuant to this Agreement do not cover and specifically excludes system upgrades and the replacement of obsolete systems, equipment, components or parts. All such services may be provided by Company at Company's sole discretion at an additional charge. If Emergency Services are expressly included in the scope of work section, the Agreement price does not include travel expenses.

28. No Option to Solicit. Customer shall not, directly or indirectly, on its own behalf or on behalf of any other person, business, corporation or entity, solicit or employ any Company employee, or induce any Company employee to leave his or her employment, for a period of two years after termination of this Agreement.

29. Force Majeure; Delays. Company shall not be liable for any damage or penalty for delays or failure to perform work due to acts of God, acts or omissions of Customer, acts of civil or military authorities, Government regulations or priorities, fires, epidemics, quarantine, restrictions, war, riots, civil disobedience or unrest, strikes, delays in transportation, vehicle shortages, differences with workmen, inability to obtain necessary labor, material or manufacturing facilities, defaults of Company's subcontractors, failure or delay in furnishing complete information by Customer with respect to location or other details of work to be performed, impossibility or impracticability of performance or any other cause or causes beyond Company's control, whether or not similar to the foregoing. In the event of any delay caused as aforesaid, completion shall be extended for a period equal to any such delay, and this contract shall not be void or voidable as a result of the delay. In the event work is temporarily discontinued by any of the foregoing, all unpaid installments of the contract price, less an amount equal to the value of material and labor not furnished, shall be due and payable upon receipt of invoice by Customer.

30. One-Year Limitation on Actions; Choice of Law. It is agreed that no suit, or cause of action or other proceeding shall be brought against either party more than one (1) year after the accrual of the cause of action or one (1) year after the claim arises, whichever is shorter, whether known or unknown when the claim arises or whether based on tort, contract, or any other legal theory. The laws of Massachusetts shall govern the validity, enforceability, and interpretation of this Agreement.

31. Assignment. Customer may not assign this Agreement without Company's prior written consent. Company may assign this Agreement to an affiliate without obtaining Customer's consent.

32. Entire Agreement. The parties intend this Agreement,

together with any attachments or Riders (collectively the "Agreement") to be the final, complete and exclusive expression of their Agreement and the terms and conditions thereof. This Agreement supersedes all prior representations, understandings or agreements between the parties, written or oral, and shall constitute the sole terms and conditions of sale for all equipment and services. No waiver, change, or modification of any terms or conditions of this Agreement shall be binding on Company unless made in writing and signed by an Authorized Representative of Company.

33. Severability. If any provision of this Agreement is held by any court or other competent authority to be void or unenforceable in whole or in part, this Agreement will continue to be valid as to the other provisions and the remainder of the affected provision.

34. Legal Fees. Company shall be entitled to recover from the customer all reasonable legal fees incurred in connection with Company enforcing the terms and conditions of this Agreement.

35. License Information (Security System Customers): AL Alabama Electronic Security Board of Licensure 7956 Vaughn Road, Pmb 392, Montgomery, Alabama 36116 (334) 264-9388; AR Regulated by: Arkansas Board of Private Investigators And Private Security Agencies, #1 State Police Plaza Drive, Little Rock 72209 (501)618-8600; CA Alarm company operators are licensed and regulated by the Bureau of Security and Investigative Services, Department of Consumer Affairs, Sacramento, CA, 95814. Upon completion of the installation of the alarm system, the alarm company shall thoroughly instruct the purchaser in the proper use of the alarm system. Failure by the licensee, without legal excuse, to substantially commence work within 20 days from the approximate date specified in the agreement when the work will begin is a violation of the Alarm Company Act; NY Licensed by N.Y.S. Department of the State; TX Texas Commission on Private Security, 5805 N. Lamar Blvd., Austin, 78752-4422, 512-424-7710. License numbers available at www.jci.com or contact your local Johnson Controls office.

<p>Offered By: Johnson Controls Fire Protection LP License#</p> <p>2788 N Larkin Ave Ste 101 FRESNO, CA 93727-1315 Telephone: (559) 348 0614</p> <p>Representative: <u>Grant Barnes</u></p> <p>Email: <u>gbarnes@simplexgrinnell.com</u></p>	<p>Accepted By: (Customer)</p> <p>Company: _____</p> <p>Address: _____</p> <p>Signature: _____</p> <p>Title: _____</p> <p>P.O.#: _____ Date: _____</p>
--	--

Tulare Local Healthcare District dba Tulare Regional Medical Center

Agenda Item

Board Meeting Date: 07-17-18

Title to Appear on Agenda: Recommendation for flooring installation/Repair

Brief Description: Ceramic Tiles in the Kitchen and OR are cracked or missing and need to be replaced.

Background and Details: Areas specific to the Kitchen and OR have cracked and chipped tiles that are infection control risks. These tiles have been this way for some time. The Kitchen has sporadic chipping and all 3 OR rooms require tile repairs. This is to comply with Title 24 and Title 22.

Bid obtained, see attached. One Vendor did not submit bids at last minute and declined

Kitchen repairs-\$4,743

OR repairs-\$5,675

Exhibits: See attached

Recommended Action: Hospital Board approve Visalia Ceramic Tile to proceed with proposed scope of work delineated in proposals.

VISALIA CERAMIC TILE, INC.

917 North American Street
Visalia, CA 93291

Phone: (559) 651-2925

Fax: (559) 651-2982

Contractor License # 481599 (C-54)

DIR Registration #100000896

VCT Estimator: Ron Mendes 559-804-7293

PROPOSAL / FACSIMILE

M/W/DBE - Certificate #27612 100% qualification

SBE - Certificate #28197 100% qualification

DVBE Supplier Option- Tier 2 meets qualification

Bonding Capacity over \$5,000,000.

THIS BID MAY HELP TO ACHIEVE YOUR DVBE GOAL - CALL US

Date of Bid: March 15, 2018 Time:ASAP

Visalia Ceramic Tile, INC is responding to the "Request for Bids"

on the:

Project: TRMC Kitchen Repairs

Location: Tulare, California

To: Tulare Regional Medical Center

Attention: George Canto

Phone: 280-6381

Fax: 685-3832

Email: gcanto@tulareregional.org

Section number(s) Per Job Walk - Ceramic Tile

hereby proposes to furnish all labor, materials, taxes and license, FOB jobsite.

This price is to cover all expenses incurred in performing the work in sections noted above and/or as follows:

Thin Set Method _____

Repair Verious Areas Per Job Walk - Kitchen

8X8 OT 01 _____

12X12 Mission Red Cut To 9"X9" _____

Black Grout _____

Exclusions are as follows:

Bonds, _____

Moving Large Equipment _____

BASE BID: \$ 4,743.00 Add P&P bonds for: \$250.00

Description of Additive / Deductive / Options

OPTION NO. 1: _____

OPTION NO. 2: _____

OPTION NO. 3: _____

Addenda's Noted in bid: _____

This bid shall be good for 45 days after bid date above. Subcontract Agreement to 5% Retention

This bid excludes payment and performance bonds, bonds purchased for \$250.00

Visalia Ceramic Tile will not be liable for drains plugged caused by negligence of others.

Costs of websites for this project and hard copies of plans and specifications excluded.

ACCEPTANCE OF PROPOSAL & acknowledgment of Exhibit A attached -

Visalia Ceramic Tile, INC is authorized to do the work as specified and all the terms in "Exhibit A" attached.

Person below has full authority to sign on behalf of responsible party requesting work.

Signature:

Print Name

Date

VISALIA CERAMIC TILE, INC.

917 North American Street

Visalia, CA 93291

Phone: (559) 651-2925

Fax: (559) 651-2982

Contractor License # 481599 (C-54)

DIR Registration #100000896

VCT Estimator: Ron Mendes 559-804-7293

PROPOSAL / FACSIMILE

M/W/DBE - Certificate #27612 100% qualification

SBE - Certificate #28197 100% qualification

DVBE Supplier Option- Tier 2 meets qualification

Bonding Capacity over \$5,000,000.

THIS BID MAY HELP TO ACHIEVE YOUR DVBE GOAL - CALL US

Date of Bid: May 29, 2018 Time:ASAP

Visalia Ceramic Tile, INC is responding to the "Request for Bids" on the:

Project: TRMC Tile Repairs

Location: Tulare, California

To: Tulare Regional Medical Center

Attention: Sandra Gomez

Phone: 685-3477

Fax: 685-3832

Email: sgomez@tulareregional.org

Section number(s) Per Job Walk - Ceramic Tile

hereby proposes to furnish all labor, materials, taxes and license, FOB jobsite.

This price is to cover all expenses incurred in performing the work in sections noted above and/or as follows:

Thin Set Method _____

Repair Wall Tiles Per Job Walk OR _____

4 1/4 0100 White _____

Exclusions are as follows:

Bonds, _____

BASE BID: \$ 5,675.00 Add P&P bonds for: \$250.00

Description of Additive / Deductive / Options

OPTION NO. 1: _____

OPTION NO. 2: _____

OPTION NO. 3: _____

Addenda's Noted in bid: _____

This bid shall be good for 45 days after bid date above. Subcontract Agreement to 5% Retention

This bid excludes payment and performance bonds, bonds purchased for \$250.00

Visalia Ceramic Tile will not be liable for drains plugged caused by negligence of others.

Costs of websites for this project and hard copies of plans and specifications excluded.

ACCEPTANCE OF PROPOSAL & acknowledgment of Exhibit A attached -

Visalia Ceramic Tile, INC is authorized to do the work as specified and all the terms in "Exhibit A" attached.

Person below has full authority to sign on behalf of responsible party requesting work.

Signature:

Print Name

Date

Tulare Local Healthcare District dba Tulare Regional Medical Center

Agenda Item

Board Meeting Date: 07-17-18

Title to Appear on Agenda: Generator load test and Maintenance agreement

Brief Description: Annual Generator load test and Maintenance

Background and Details: As part of NFPA 110, the hospital's Emergency Power Supply System (EPSS-Generators) need to be tested under load annually. They have not been tested since last year. This is to ensure the functionality of the Generators are capable of maintaining operations. Also, included is a maintenance agreement to help minimize delays in repairs and mitigate potential unforeseen issues along the way. Because of the life safety component this would also be a NFPA life safety 101 code.

Because of the history and familiarity with this vendor and our hospital generators, one sole bid was obtained.

Load Bank 4 hour test-\$8323.77

Service Agreement-\$7,509.15

Exhibits: See attached

Recommended Action: Hospital Board approve Cummins Pacific to proceed with proposed scope of work delineated in proposals.



1/24/2018

Tulare Regional Medical
Attn Accounts Payable
869 Cherry St
Tulare, CA 93274
RE: Planned Maintenance Proposal

Dear George Canto,

Cummins Pacific, LLC is a premier engine and power generation systems and services provider committed to delivering fast and proven solutions to our customers. We are pleased to offer you a Planned Equipment Maintenance "Agreement" proposal for your review and approval. Due to the critical nature of your standby power system, this Agreement was developed based on your specific needs and equipment to ensure maximum performance and reliability.

Benefits of Planned Maintenance

- Improves system reliability.
- Maintenance performed by certified technicians specifically trained in power generation.
- PM customers receive preferred service for unscheduled emergency repairs.
- Creation of a service record for customer equipment.
- Additional maintenance recommendations documented at that time.
- Scheduling managed by Cummins Pacific, LLC to ensure timely maintenance intervals.
- Eliminates administrative burden, covers equipment from multiple vendors.

Please sign, date and return the enclosed Agreement to our office along with any purchase documentation necessary so we can tend to your servicing needs. Planned Maintenance Agreements are "auto-renewed" annually prior to the end of your agreement. Should you have any questions or require additional information on this or any other subject relating to your equipment, please feel free to contact me. We look forward to the opportunity to earn your trust and business.

Sincerely,

Mike McCormick

Mike McCormick
Territory Manager
Office: 661-326-4026
Cell: (661) 377-8351
Email: mike.mccormick@cummins.com



Cummins Pacific, LLC
 5333 North Cornelia Ave.
 Fresno, CA 93722
 Phone: (559) 274-4400
 Fax:

PLANNED EQUIPMENT MAINTENANCE AGREEMENT

Customer Address	Customer Contact	Quote Information	
Tulare Regional Medical	Name: George Canto	Quote Date:	1/24/2018
Attn Accounts Payable	Phone: (559) 688-0821	Quote Expires:	3/25/2018
869 Cherry St	Cell: 559-280-6381	Quote ID:	QT-4229
Tulare, CA 93274	Fax: (559) 688-2754	Quoted By:	Mike McCormick
Customer #: 90763	E-mail: gcanto@teamhcca.com	Quote Term:	1 Year
Payment Type: Pay As You Go			

Site Name:TULARE DISTRICT HOSPITAL

(869 CHERRY STREET TULARE CA 93274)

Unit Name:	1	Year	Month of 1st Service	Service Type	Qty	Sell Price	Extended Price
Make:	Onan	1	January	Loadbank (4 Hrs)	1	\$5,358.81	\$5,358.81
Model:	1250DFLC						
S/N:	A930497805						
Size:	1250kW						
ATS Qty:	1						
Notes:							

Unit Name:	2	Year	Month of 1st Service	Service Type	Qty	Sell Price	Extended Price
Make:	Caterpillar	1	January	Loadbank (4 Hrs)	1	\$2,964.96	\$2,964.96
Model:	3208						
S/N:	5YF01136						
Size:	200kW						
ATS Qty:	1						
Notes:							

Total Agreement Amount:* \$8,323.77
**Quote does not include applicable taxes*



Cummins Pacific, LLC
 5333 North Cornelia Ave.
 Fresno, CA 93722
 Phone: (559) 274-4400

PLANNED EQUIPMENT MAINTENANCE AGREEMENT

Customer Address	Customer Contact	Quote Information
Tulare Regional Medical	Name: George Canto	Quote Date: 1/24/2018
Attn Accounts Payable	Phone: (559) 688-0821	Quote Expires: 3/25/2018
869 Cherry St	Cell: 559-280-6381	Quote ID: QT-4229
Tulare, CA 93274	Fax: (559) 688-2754	Quoted By: Mike McCormick
Customer #: 90763	E-mail: gcanto@teamhcca.com	Quote Term: 1 Year
Payment Type: Pay As You Go		

Total Agreement Amount:*

\$8,323.77

**Quote does not include applicable taxes*

Comment:

ONE 4 HOUR LOAD BANK TEST FOR EACH UNIT

The purpose of Load Bank Test is to check the reliability of the generator. During testing the generator, alternator or other components may fail. Cummins Pacific LLC is not responsible for any generator failure or other defects found during testing. The technician will attempt to hook the load bank cables to output side of the breaker, if this is not possible they will attempt to hook up through the CT's to protect the generator. If the customer wants the unit to be available for emergency use during the testing or there is no room to install the load bank cables on the breaker safely we will hook up to the alternator output, this provides no protection during testing.

Thank you for the opportunity to earn your business.

ALL SERVICES ARE QUOTED TO BE PERFORMED DURING NORMAL BUSINESS HOURS, 7:30AM - 4:30PM
 AFTER HOURS EMERGENCY RESPONSE: 800-304-8787

Total Agreement Amount does not include applicable taxes. Please Email PMTEAM@cummins.com for invoice total prior to sending payment.

Planned Equipment Maintenance Agreements are designed with an automatic renewal provision. Details of this provision are listed in the "Planned Equipment Maintenance Agreement Terms and Conditions". If you do not wish to participate in the auto renew option, please check the box below to opt out.

Opt out of Automatic Renewal.

Selection Required for Load Bank Test

Readings will be taken every 15 minutes, unless otherwise specified.

*If no selection is made, we will perform this option by default

- *30% of the EPS nameplate kW rating for 30 minutes, followed by 50% of the EPS nameplate kW rating for 30 minutes, followed by 75% of the EPS nameplate kW rating for 180 minutes for a total of 4 continuous hours
- 80% of the EPS nameplate kW rating for 4 continuous hours
- Other – Please Specify _____

Please return signed agreement to:

My mailing or fax information provided above, or
 Email: PMTEAM@cummins.com

Cummins Pacific, LLC ("CP") hereby agrees to sell to Customer, and Customer hereby agrees to buy from CP, the foregoing products/services upon the terms and conditions set forth in the "Planned Equipment Maintenance Agreement Terms and Conditions" attached hereto, which are hereby incorporated herein by reference.

Customer Approval (Quote ID QT-4229)

Gurmins Pacific, LLC Approval

Signature: _____ Signature: _____

Date: _____ Date: _____

Please return this sheet only.

PLANNED MAINTENANCE AGREEMENT TERMS AND CONDITIONS

These Planned Maintenance Agreement Terms and Conditions, together with the Quote on the front side and the Scope of Services, are hereinafter referred to as this "Agreement" and shall constitute the entire agreement between the customer identified in the Quote ("Customer") and Cummins and supersedes any previous agreement or understanding (oral or written) between the parties with respect to the subject matter of this Agreement.

1. SCOPE OF SERVICES; PERFORMANCE OF SERVICES. Cummins shall perform the maintenance ("Services") on the equipment identified in the Quote ("Equipment") in accordance with the schedule specified in the Quote. The Services include those services defined in the "Service Event" section of the Quote. No additional services or materials are included in this Agreement unless agreed upon by the parties in supplemental documentation.

Cummins shall provide the Services in a safe and workmanlike manner. Cummins has licenses, authorizations, or registrations necessary to perform the Services. Unless otherwise indicated in the Quote, Cummins will provide the labor and tools necessary to perform the Services and shall keep Customer's property free from accumulation of waste materials caused by Cummins' operations.

Customer shall provide Cummins safe access to Customer's site and arrange for all related services and utilities necessary for Cummins to perform the Services. During the performance of the Services, Customer shall fully and completely secure all or any part of any facility where the Equipment is located for any and all safety issues that an electrical service interruption might cause, including but not limited to injury to facility occupants, customers, invitees, or any third party and/or property damage or work interruption arising out of the Services.

Either party may terminate this Agreement with or without cause by providing thirty (30) days written notice to the other.

2. PAYMENT TERMS. If Customer has approved credit, as determined by Cummins, payment terms are net thirty (30) days from the date of invoice unless otherwise specified in the Quote. If payment is not received when due, in addition to any rights Cummins has under the law and charges that Cummins may levy against Customer under statute (including attorney fees and costs of collection), Cummins may charge Customer eighteen percent (18%) annually, or the maximum amount allowed by law, on late payments. Payment shall be due in advance if Customer does not have approved credit.

3. DELAYS. Cummins shall not be liable for any delays in performance that result directly or indirectly from acts of Customer or causes beyond Cummins' control, including but not limited to acts of God, accidents, fire, explosions, flood, unusual weather conditions, acts of government authority, or labor disputes.

4. WARRANTY. Limited warranties apply for select parts and components as defined by the respective component manufacturer's limited warranties. All Services shall be free from defects in workmanship for a period of ninety (90) days after completion of Services. In the event of a warrantable defect in workmanship, Cummins' obligation shall be limited to correcting the defective workmanship. Cummins shall correct the nonconforming Services where (i) such nonconformity becomes apparent to Customer during the warranty period; (ii) Cummins receives written notice of any nonconformity within thirty (30) days following discovery by Customer; and (iii) Cummins has determined that the Services are nonconforming. Services corrected or re-performed shall be subject to the remaining warranty period of the original warranty of the Services. New parts supplied during correction or re-performance of Services are warranted for the balance of the warranty period still available from the original warranty of such parts. The remedies set forth in this Section 4 shall not be deemed to have failed of their essential purpose so long as Cummins is willing to correct defective Services or refund the purchase price therefor.

5. LIMITATIONS ON WARRANTIES AND REMEDIES.

Cummins expressly disclaims all warranties, either express or implied, including any implied warranty of merchantability and warranty for fitness of a particular purpose, to the extent permitted by law. The warranties set forth herein are the sole warranties made by Cummins. Some states do not allow limitation on warranties, so these limitations may not apply to you.

THE MAXIMUM LIABILITY, IF ANY, OF EITHER PARTY FOR ANY DAMAGES, INCLUDING WITHOUT LIMITATION, AGREEMENT DAMAGES AND DAMAGES FOR PROPERTY, WHETHER ARISING FROM CUMMINS' INDEMNITY HEREUNDER, BREACH OF AGREEMENT, BREACH OF WARRANTY, NEGLIGENCE, STRICT LIABILITY, OR OTHER TORT, IS LIMITED TO AN AMOUNT NOT TO EXCEED TWO TIMES THE PRICE OF THE SERVICES PAID BY CUSTOMER UNDER THIS AGREEMENT WHICH SHALL BE THE SOLE REMEDY UNDER THIS AGREEMENT. IN NO EVENT SHALL EITHER PARTY BE LIABLE FOR INDIRECT, INCIDENTAL, SPECIAL, PUNITIVE, OR CONSEQUENTIAL DAMAGES OF ANY KIND (INCLUDING WITHOUT LIMITATION DOWNTIME, PROPERTY DAMAGE, LOSS OF PROFIT OR REVENUE, LOSS OF DATA, DAMAGE TO GOODWILL) HOWSOEVER CAUSED ARISING FROM THIS AGREEMENT OR THE BREACH OF THIS AGREEMENT, WHETHER IN INDEMNITY, TORT, CONTRACT, OR OTHERWISE. NOTHING IN THIS AGREEMENT EXCLUDES OR LIMITS LIABILITY FOR DEATH OR PERSONAL INJURY CAUSED BY A PARTY'S GROSS NEGLIGENCE OR WILLFUL MISCONDUCT. BY ACCEPTANCE OF THIS AGREEMENT, CUSTOMER ACKNOWLEDGES CUSTOMER'S SOLE REMEDY AGAINST CUMMINS FOR ANY LOSS SHALL BE THE REMEDY PROVIDED HEREIN.

6. INDEMNITY. Each party shall indemnify and hold harmless the other party, its affiliates, subsidiaries, officers, directors, agents and employees from and against any and all third party losses, costs, liabilities, damages and expense, including reasonable attorney and expert fees (collectively, "Losses"), subject to the limitations on claims and damages in Section 5, attributable to bodily injury or property damage to the extent it is conclusively determined that such Losses were directly caused by the gross negligence or willful misconduct of such party. The party seeking indemnification shall give written notice to the other party promptly upon learning of the events giving rise to such claim; provided, however, that failure to provide such notice promptly shall only relieve an indemnifying party of its obligations hereunder to the extent it is prejudiced by such delay. The indemnifying party shall select counsel to control and manage the defense of a claim and the settlement thereof and shall keep the indemnified party apprised of all material developments with respect to such claim. The indemnified party may, at its expense, select additional co-counsel. The indemnifying party shall have no obligation to indemnify or hold harmless the indemnified party for any Losses conclusively determined to be caused by the negligence or willful misconduct of the indemnified party.

7. CONFIDENTIALITY. Each party shall keep confidential any information received from the other that is not generally known to the public and at the time of disclosure, would reasonably be understood by the receiving party to be proprietary or confidential, whether disclosed in oral, written, visual, electronic or other form, and which the receiving party (or agents) learns in connection with this Agreement including, but not limited to: (a) business plans, strategies, sales, projects and analyses; (b) financial information, pricing, and fee structures; (c) business processes, methods and models; (d) employee and supplier information; (e) specifications; and (f) the terms and conditions of this Agreement. Each party shall take necessary steps to ensure compliance with this provision by its employees, and agents.

8. GOVERNING LAW. This Agreement shall be governed by and construed in accordance with the laws of the State of Indiana without giving effect to any choice or conflict of law provision. The parties agree that the courts of the State of Indiana shall have exclusive jurisdiction to settle any dispute or claim arising in connection with this Agreement.

9. INSURANCE. Upon Customer's request, Cummins will provide to Customer a Certificate of Insurance evidencing Cummins' relevant insurance coverage.

10. ASSIGNMENT. This Agreement shall be binding on the parties and their successors and assigns. Customer shall not assign this Agreement without the prior written consent of Cummins.

11. INTELLECTUAL PROPERTY. Any intellectual property rights created by Cummins in the course of the performance of any Agreement or otherwise shall remain Cummins' property. Nothing in these conditions shall be deemed to have given Customer a license or any other rights to use any of the intellectual property rights of Cummins.

12. MISCELLANEOUS. Cummins shall be an independent contractor with respect to the Services performed under this Agreement. All notices under this Agreement shall be in writing and be delivered personally, mailed via first class certified or registered mail, or sent by a nationally recognized express courier service to the addresses set forth in the Quote. No amendment of this Agreement shall be valid unless it is in writing and signed by the parties hereto. Failure of either party to require performance by the other party of any provision hereof shall in no way affect the right to require such performance at any time thereafter, nor shall the waiver by a party of a breach of any of the provisions hereof constitute a waiver of any succeeding breach. Any provision of this Agreement that is invalid or unenforceable shall not affect the validity or enforceability of the remaining terms hereof.



Generator Planned Maintenance Scope of Services

The following items are included in a typical Planned Maintenance Agreement (PMA):

Scheduled Checks

Cooling System

- Radiator air restriction
- Condition of hoses and connection leaks
- Antifreeze and coolant conditioner concentration
- Condition and tension of belts
- Ensure motor-operated louvers are working properly
- Pressure Testing

Air intake System

- Visually check for leaks, holes, and loose connections/clamps

Exhaust System

- Visually check for leaks and restrictions
- Drain condensation trap

Electrical System

- Review meters for proper operation
- Specific gravity of battery liquid

Fuel System

- Proper fuel levels
- Fuel transfer pump

Annual Checks

Maintenance

- Change oil
- Oil sample (optional)
- Change filters
- Disposal of used oil and filters

Diesel Engine Checks

- Starter and all wiring
- Oil and coolant levels

Generator

- End bearing
- A.C. wiring
- Exciter stator
- Overspeed switch
- Cooling air
- Breakers

Engine Running

- Oil Pressure
- Leaks
- Alternator output
- Alarm
- Record A.C. output
- Frequency
- Amps under load

Intake and Exhaust Check

- Air cleaner
- Turbocharger
- Muffler and traps
- Leaks
- Breather
- Flex pipe
- Rain cap

Natural Gas and Gasoline Engine Checks

- Spark plugs
- Distributor wires
- Points and condenser
- Cap and rotor
- Starter and all wiring
- Oil and coolant levels

Controls

- Voltage regulator
- Wiring and relays
- Engine monitors
- Bulbs

Coolant System Check Only

- Antifreeze
- Radiator and cap
- Hoses and heater
- Belts and tension
- Louvers
- Coolant sample (optional)
- Leaks
- DCA level

Transfer Switch

- Time delays (adjust as needed)
- Exerciser clock (reset as needed)
- Clean cabinet
- Building load test (if permitted)

Fuel System

- Leaks
- Day tank - float switch pump
- Governor linkage
- Check for water in system

Semi Annual Checks

Battery and Charger

- Specific gravity test
- Clean corrosion as needed
- Adjust charger output as needed

Request Service: **1-800-CUMMINS**
salesandservice.cummins.com



5/8/2018

Tulare Regional Medical
Attn Accounts Payable
869 Cherry St
Tulare, CA 93274
RE: Planned Maintenance Proposal

Dear George Canto,

Cummins Sales and Service is a premier engine and power generation systems provider committed to delivering fast and proven solutions to our customers. We are pleased to offer you a Planned Maintenance Proposal for your review and approval. Due to the critical nature of your standby power system, this Agreement was developed based on your specific needs and equipment to ensure maximum performance and reliability.

Benefits of Planned Maintenance

- Improves system reliability.
- Maintenance performed by certified technicians specifically trained in power generation.
- PM customers receive preferred service for unscheduled emergency repairs.
- Creation of a service record for customer equipment.
- Additional maintenance recommendations documented at that time.
- Scheduling managed by Cummins Sales and Service to ensure timely maintenance intervals.
- Eliminates administrative burden, covers equipment from multiple vendors.

Please sign, date and return the enclosed Agreement to our office along with any purchase documentation necessary so we can tend to your servicing needs. Planned Maintenance Agreements are "auto-renewed" annually prior to the end of your agreement. Should you have any questions or require additional information on this or any other subject relating to your equipment, please feel free to contact me. We look forward to the opportunity to earn your trust and business.

Sincerely,

Mike McCormick

Mike McCormick
Territory Manager
Office: 661-326-4026
Cell: (661) 377-8351
Email: mike.mccormick@cummins.com



Cummins Inc.
 5333 North Cornelia Ave.
 Fresno, CA 93722
 Phone: (559) 274-4400
 Fax:

PLANNED EQUIPMENT MAINTENANCE AGREEMENT

Customer Address	Customer Contact	Quote Information	
Tulare Regional Medical	Name: George Canto	Quote Date:	5/8/2018
Attn Accounts Payable	Phone: (559) 688-0821	Quote Expires:	7/7/2018
869 Cherry St	Cell: (559) 331-4021	Quote ID:	QT-5083
Tulare, CA 93274	Fax: (559) 688-2754	Quoted By:	Mike McCormick
Customer #: 90763	E-mail: GCANTO@TEAMHCCA.COM	Quote Term:	2 Year
Payment Type: Pay As You Go			

Site Name:TULARE DISTRICT HOSPITAL
 (869 CHERRY STREET TULARE CA 93274)

Unit Name:	1	Year	Month of 1st Service	Service Type	Qty	Sell Price	Extended Price	
Make:	Onan	1	December	Full Service	1	\$2,509.91	\$2,509.91	
Model:	1250DFLC						Year 1 Total:\$2,509.91	
S/N:	A930497805							
Size:	1250kW	2	December	Full Service	1	\$2,580.61	\$2,580.61	
ATS Qty:	1						Year 2 Total:\$2,580.61	
Notes:								

Unit Name:	2	Year	Month of 1st Service	Service Type	Qty	Sell Price	Extended Price	
Make:	Caterpillar	1	December	Full Service	1	\$1,193.71	\$1,193.71	
Model:	3208						Year 1 Total:\$1,193.71	
S/N:	5YF01136							
Size:	200kW	2	December	Full Service	1	\$1,224.92	\$1,224.92	
ATS Qty:	1						Year 2 Total:\$1,224.92	
Notes:								

Year 1 Total:* \$3,703.62
 Year 2 Total:* \$3,805.53

Total Agreement Amount:* \$7,509.15

**Quote does not include applicable taxes*



Cummins Inc.
 5333 North Cornelia Ave.
 Fresno, CA 93722
 Phone: (559) 274-4400

PLANNED EQUIPMENT MAINTENANCE AGREEMENT

Customer Address	Customer Contact	Quote Information
Tulare Regional Medical Attn Accounts Payable 869 Cherry St Tulare, CA 93274 Customer #: 90763 Payment Type: Pay As You Go	Name: George Canto Phone: (559) 688-0821 Cell: (559) 331-4021 Fax: (559) 688-2754 E-mail: GCANTO@TEAMHCCA.COM	Quote Date: 5/8/2018 Quote Expires: 7/7/2018 Quote ID: QT-5083 Quoted By: Mike McCormick Quote Term: 2 Year

Total Agreement Amount:* **\$7,509.15**
**Quote does not include applicable taxes*

Comment: Quotation provides for one Full Service annually on both the 1250kw and the 200kw generator sets for a term of two (2) years.

Tentative Schedule:

- 1st year service month- December 2016
- 2nd year service month- December 2017

Does not include rental unit if required

This proposal is to provide a Planned Maintenance Agreement to service the stand-by generator at your location. Our agreement includes all labor and travel to perform the services outlined. The full service includes all applicable filters (oil and fuel), specially formulated engine oil, oil sample test, and oil disposal in accordance with CA regulations. If a unit needs belts, batteries, a tune-up or the replacement of a failed part (s), the technician who performs the service will bring the item (or items) to your attention and obtain approval prior to performing the repair.

Total Agreement Amount Does Not Include Applicable Taxes. Please Email PMTEAM@cummins.com for invoice total prior to sending payment.

Planned Equipment Maintenance Agreements are designed with an automatic renewal provision. Details of this provision are listed in the "Planned Equipment Maintenance Agreement Terms and Conditions". If you do not wish to participate in the auto renew option, please check the box below to opt out.

Opt out of Automatic Renewal.

Seller hereby agrees to sell to Buyer, and Buyer hereby agrees to buy from Seller, the foregoing products/services upon the terms and conditions set forth in the "Planned Equipment Maintenance Agreement Terms and Conditions" attached hereto, which are hereby incorporated herein by reference.

Customer Approval (Quote ID QT-5083) **Cummins Inc. Approval**

Signature: _____ Signature: _____

Date: _____ Date: _____

PLANNED MAINTENANCE AGREEMENT TERMS AND CONDITIONS

These Planned Maintenance Agreement Terms and Conditions, together with the Quote on the front side and the Scope of Services, are hereinafter referred to as this "Agreement" and shall constitute the entire agreement between the customer identified in the Quote ("Customer") and Cummins and supersedes any previous agreement or understanding (oral or written) between the parties with respect to the subject matter of this Agreement.

1. SCOPE OF SERVICES; PERFORMANCE OF SERVICES. Cummins shall perform the maintenance ("Services") on the equipment identified in the Quote ("Equipment") in accordance with the schedule specified in the Quote. The Services include those services defined in the "Service Event" section of the Quote. No additional services or materials are included in this Agreement unless agreed upon by the parties in supplemental documentation.

Cummins shall provide the Services in a safe and workmanlike manner. Cummins has licenses, authorizations, or registrations necessary to perform the Services. Unless otherwise indicated in the Quote, Cummins will provide the labor and tools necessary to perform the Services and shall keep Customer's property free from accumulation of waste materials caused by Cummins' operations.

Customer shall provide Cummins safe access to Customer's site and arrange for all related services and utilities necessary for Cummins to perform the Services. During the performance of the Services, Customer shall fully and completely secure all or any part of any facility where the Equipment is located for any and all safety issues that an electrical service interruption might cause, including but not limited to injury to facility occupants, customers, invitees, or any third party and/or property damage or work interruption arising out of the Services.

Either party may terminate this Agreement with or without cause by providing thirty (30) days written notice to the other.

2. PAYMENT TERMS. If Customer has approved credit, as determined by Cummins, payment terms are net thirty (30) days from the date of invoice unless otherwise specified in the Quote. If payment is not received when due, in addition to any rights Cummins has under the law and charges that Cummins may levy against Customer under statute (including attorney fees and costs of collection), Cummins may charge Customer eighteen percent (18%) annually, or the maximum amount allowed by law, on late payments. Payment shall be due in advance if Customer does not have approved credit.

3. DELAYS. Cummins shall not be liable for any delays in performance that result directly or indirectly from acts of Customer or causes beyond Cummins' control, including but not limited to acts of God, accidents, fire, explosions, flood, unusual weather conditions, acts of government authority, or labor disputes.

4. WARRANTY. Limited warranties apply for select parts and components as defined by the respective component manufacturer's limited warranties. All Services shall be free from defects in workmanship for a period of ninety (90) days after completion of Services. In the event of a warrantable defect in workmanship, Cummins' obligation shall be limited to correcting the defective workmanship. Cummins shall correct the nonconforming Services where (i) such nonconformity becomes apparent to Customer during the warranty period; (ii) Cummins receives written notice of any nonconformity within thirty (30) days following discovery by Customer; and (iii) Cummins has determined that the Services are nonconforming. Services corrected or re-performed shall be subject to the remaining warranty period of the original warranty of the Services. New parts supplied during correction or re-performance of Services are warranted for the balance of the warranty period still available from the original warranty of such parts. The remedies set forth in this Section 4 shall not be deemed to have failed of their essential purpose so long as Cummins is willing to correct defective Services or refund the purchase price therefor.

5. LIMITATIONS ON WARRANTIES AND REMEDIES.

Cummins expressly disclaims all warranties, either express or implied, including any implied warranty of merchantability and warranty for fitness of a particular purpose, to the extent permitted by law. The warranties set forth herein are the sole warranties made by Cummins. Some states do not allow limitation on warranties, so these limitations may not apply to you.

THE MAXIMUM LIABILITY, IF ANY, OF EITHER PARTY FOR ANY DAMAGES, INCLUDING WITHOUT LIMITATION, AGREEMENT DAMAGES AND DAMAGES FOR PROPERTY, WHETHER ARISING FROM CUMMINS' INDEMNITY HEREUNDER, BREACH OF AGREEMENT, BREACH OF WARRANTY, NEGLIGENCE, STRICT LIABILITY, OR OTHER TORT, IS LIMITED TO AN AMOUNT NOT TO EXCEED TWO TIMES THE PRICE OF THE SERVICES PAID BY CUSTOMER UNDER THIS AGREEMENT WHICH SHALL BE THE SOLE REMEDY UNDER THIS AGREEMENT. IN NO EVENT SHALL EITHER PARTY BE LIABLE FOR INDIRECT, INCIDENTAL, SPECIAL, PUNITIVE, OR CONSEQUENTIAL DAMAGES OF ANY KIND (INCLUDING WITHOUT LIMITATION DOWNTIME, PROPERTY DAMAGE, LOSS OF PROFIT OR REVENUE, LOSS OF DATA, DAMAGE TO GOODWILL) HOWSOEVER CAUSED ARISING FROM THIS AGREEMENT OR THE BREACH OF THIS AGREEMENT, WHETHER IN INDEMNITY, TORT, CONTRACT, OR OTHERWISE. NOTHING IN THIS AGREEMENT EXCLUDES OR LIMITS LIABILITY FOR DEATH OR PERSONAL INJURY CAUSED BY A PARTY'S GROSS NEGLIGENCE OR WILLFUL MISCONDUCT. BY ACCEPTANCE OF THIS AGREEMENT, CUSTOMER ACKNOWLEDGES CUSTOMER'S SOLE REMEDY AGAINST CUMMINS FOR ANY LOSS SHALL BE THE REMEDY PROVIDED HEREIN.

6. INDEMNITY. Each party shall indemnify and hold harmless the other party, its affiliates, subsidiaries, officers, directors, agents and employees from and against any and all third party losses, costs, liabilities, damages and expense, including reasonable attorney and expert fees (collectively, "Losses"), subject to the limitations on claims and damages in Section 5, attributable to bodily injury or property damage to the extent it is conclusively determined that such Losses were directly caused by the gross negligence or willful misconduct of such party. The party seeking indemnification shall give written notice to the other party promptly upon learning of the events giving rise to such claim; provided, however, that failure to provide such notice promptly shall only relieve an indemnifying party of its obligations hereunder to the extent it is prejudiced by such delay. The indemnifying party shall select counsel to control and manage the defense of a claim and the settlement thereof and shall keep the indemnified party apprised of all material developments with respect to such claim. The indemnified party may, at its expense, select additional co-counsel. The indemnifying party shall have no obligation to indemnify or hold harmless the indemnified party for any Losses conclusively determined to be caused by the negligence or willful misconduct of the indemnified party.

7. CONFIDENTIALITY. Each party shall keep confidential any information received from the other that is not generally known to the public and at the time of disclosure, would reasonably be understood by the receiving party to be proprietary or confidential, whether disclosed in oral, written, visual, electronic or other form, and which the receiving party (or agents) learns in connection with this Agreement including, but not limited to: (a) business plans, strategies, sales, projects and analyses; (b) financial information, pricing, and fee structures; (c) business processes, methods and models; (d) employee and supplier information; (e) specifications; and (f) the terms and conditions of this Agreement. Each party shall take necessary steps to ensure compliance with this provision by its employees, and agents.

8. GOVERNING LAW. This Agreement shall be governed by and construed in accordance with the laws of the State of Indiana without giving effect to any choice or conflict of law provision. The parties agree that the courts of the State of Indiana shall have exclusive jurisdiction to settle any dispute or claim arising in connection with this Agreement.

9. INSURANCE. Upon Customer's request, Cummins will provide to Customer a Certificate of Insurance evidencing Cummins' relevant insurance coverage.

10. ASSIGNMENT. This Agreement shall be binding on the parties and their successors and assigns. Customer shall not assign this Agreement without the prior written consent of Cummins.

11. INTELLECTUAL PROPERTY. Any intellectual property rights created by Cummins in the course of the performance of any Agreement or otherwise shall remain Cummins' property. Nothing in these conditions shall be deemed to have given Customer a license or any other rights to use any of the intellectual property rights of Cummins.

12. MISCELLANEOUS. Cummins shall be an independent contractor with respect to the Services performed under this Agreement. All notices under this Agreement shall be in writing and be delivered personally, mailed via first class certified or registered mail, or sent by a nationally recognized express courier service to the addresses set forth in the Quote. No amendment of this Agreement shall be valid unless it is writing and signed by the parties hereto. Failure of either party to require performance by the other party of any provision hereof shall in no way affect the right to require such performance at any time thereafter, nor shall the waiver by a party of a breach of any of the provisions hereof constitute a waiver of any succeeding breach. Any provision of this Agreement that is invalid or unenforceable shall not affect the validity or enforceability of the remaining terms hereof.



Generator Planned Maintenance Scope of Services

The following items are included in a typical Planned Maintenance Agreement (PMA):

Scheduled Checks

Cooling System

- Radiator air restriction
- Condition of hoses and connection leaks
- Antifreeze and coolant conditioner concentration
- Condition and tension of belts
- Ensure motor-operated louvers are working properly
- Pressure Testing

Air intake System

- Visually check for leaks, holes, and loose connections/clamps

Exhaust System

- Visually check for leaks and restrictions
- Drain condensation trap

Electrical System

- Review meters for proper operation
- Specific gravity of battery liquid

Fuel System

- Proper fuel levels
- Fuel transfer pump

Annual Checks

Maintenance

- Change oil
- Oil sample (optional)
- Change filters
- Disposal of used oil and filters

Diesel Engine Checks

- Starter and all wiring
- Oil and coolant levels

Generator

- End bearing
- A.C. wiring
- Exciter stator
- Overspeed switch
- Cooling air
- Breakers

Engine Running

- Oil Pressure
- Leaks
- Alternator output
- Alarm
- Record A.C. output
- Frequency
- Amps under load

Intake and Exhaust Check

- Air cleaner
- Turbocharger
- Muffler and traps
- Leaks
- Breather
- Flex pipe
- Rain cap

Natural Gas and Gasoline Engine Checks

- Spark plugs
- Distributor wires
- Points and condenser
- Cap and rotor
- Starter and all wiring
- Oil and coolant levels

Controls

- Voltage regulator
- Wiring and relays
- Engine monitors
- Bulbs

Coolant System Check Only

- Antifreeze
- Radiator and cap
- Hoses and heater
- Belts and tension
- Louvers
- Coolant sample (optional)
- Leaks
- DCA level

Transfer Switch

- Time delays (adjust as needed)
- Exerciser clock (reset as needed)
- Clean cabinet
- Building load test (if permitted)

Fuel System

- Leaks
- Day tank - float switch pump
- Governor linkage
- Check for water in system

Semi Annual Checks

Battery and Charger

- Specific gravity test
- Clean corrosion as needed
- Adjust charger output as needed

Request Service: **1-800-CUMMINS**
salesandservice.cummins.com

Tulare Local Healthcare District dba Tulare Regional Medical Center

Agenda Item

Board Meeting Date: 07-17-18

Title to Appear on Agenda: Nurse call upgrade for MS 1 and MS 2

Brief Description: Upgrade for existing nurse call system for MS 1 and MS 2

Background and Details: The West-Com system is in need of upgrades for both MS 1 and MS 2. This is a proprietary system. This is needed to maintain both life safety measures and customer service.

Sole bid presented as this is a proprietary system

Nurse call upgrades-\$53, 822.08

Exhibits: See attached

Recommended Action: Hospital Board approve West-Com to proceed with proposed scope of work delineated in proposal.

Date :	April 27, 2018	 West-Com <small>& T.V., Inc.</small> www.westcall.com 2200 Cordelia Road Fairfield, CA 94534 (707)428-5902 Phone (707)428-5938 Fax
Quote Number :	1804-27 R1	
Quote To:	George Canto	
Hospital:	Tulare Medical	
Area:	1st & 2nd fl	
System:	Existing	
Project:	FC upgrade Budgetary	

<u>Qty</u>	<u>Part No. / Model No.</u>	<u>Description</u>	<u>Cost Each</u>	<u>Cost Extended</u>
3	30121020 - FCNS-SPK	External Speaker, USB port powered	\$ 96.60	\$ 289.80
4	EN350	UPS, 350 Watt (FC CDT & Master Exchanges)	\$ 94.99	\$ 379.96
1	30137131 - FCNS-15/CDT	15" Call Display Terminal, keyboard, mouse and FocusCare CDT License.	\$ 3,220.00	\$ 3,220.00
2	30118004 - SVC-8500	Central Service Display	\$ 531.30	\$ 1,062.60
3	Focus Care Upgrade	Master maps (facility to provide CAD files)	\$ -	\$ -
3	Focus Care Upgrade	Add 1-gang box for MPP & re-use existing cable	\$ 25.02	\$ 75.06
2	Focus Care Upgrade	Upgrade CMB-8500	\$ 5,313.00	\$ 10,626.00
1	30160000 - INS	Installation and testing of any software package installed on West-Com machine. Includes all software purchased and installed on the same machine.	\$ 805.00	\$ 805.00
1	30122015 - LCD-19/NT	19" Non-Touch LCD	\$ 581.00	\$ 581.00
1	30137120 - RPC-4	Rack mount RAID Server	\$ 6,200.00	\$ 6,200.00
1	EN350	UPS, 350 Watt	\$ 94.99	\$ 94.99
3	30137116 Master Exchange	IPC-3/FC to FCNS-15/MPP Master	\$ 3,800.00	\$ 11,400.00
1	Facility to provide CAD files	to create maps on nurse station masters	\$ -	\$ -
1	Facility to provide location of F.S.	DM server	\$ -	\$ -
3	ReadyRails Static Rails	1-Gang Cut-In Box (MPP)	\$ 25.02	\$ 75.06
1	ReadyRails Static Rails	Universal 2/4 Post Rack	\$ 179.50	\$ 179.50
1	No Charge	Factory Training in Fairfield CA. (customer is responsible for all travel related expenses)	\$ -	\$ -
2	10112031 - RJ-45	RJ-45	\$ 2.42	\$ 4.84
0.5	30114010 - WNP	4pr.CAT-5, 24ga., CL2P	\$ 473.34	\$ 236.67

Equipment	\$ 34,183.97
Software	\$ 805.00
Cable	\$ 241.51
Sales Tax	\$ 2,840.11
Shipping	\$ 928.19
CAD Work	\$ 500.00
Labor	\$ 14,323.30
Total	\$ 53,822.08

FINANCING OPTION	
\$1 Buy-Out Option	
60 Month Lease Payment:	\$ 1,078.59

**All rates subject to credit approval*

**Additional financing terms available. Please contact Great America Financial at 800-314-7737 for additional financing terms and options.*

Scope of Work

Included in this proposal

- Hardware & cable specific to the Focus Care Upgrade.
- Installation of hardware & Cable
- Quote is based on a vacated area:
- Quote is based on site review and customer provided information.
- WCTV only provides universal 2 Post/4post shelf: any other shelf needed will be at an additional cost
- Shipping, tax and warranty.
- Excluded Submittals, Shop Drawings, Asbuilts & O&Ms.
- Excluded: Submission to any Agency, City or OSHPD.
- Excluded: Electrical Engineer Stamp.
- Excluded: Apprentice labor for any project. Should apprentice labor be required additional charges will apply.
- Excluded: Temporary wireless system: including labor to deploy or take down.
- Excluded: Samples
- Excluded: Mock up rooms unless specified in quote.
- Excluded: Payment & Performance Bond unless specified in quote.
- Excluded: Protection of job site.
- Standard ground freight only is included.
- Quote based upon work being done during normal business hours.
- WCTV normal business hours are: 7:00am to 3:30pm.
- Quote is based on installation being done in a single phase.
- Labor costs assume that WC install team will have free & clear pathways to/around device locations & panel rooms, and for wire pulls, before commencing work.
- Labor costs assume the West-Com installation team is able to efficiently work a full 8 hour day at site.
- Quote excludes badging procedures and safety classes/meetings. This time is additional.
- West-Com & T.V., inc is Vendormate approved.
- 1 Year Warranty Labor: See Warranty Page below.
- 5 Year Warranty Parts: WCNC manufactured parts only. See Warranty Page below.

The owner is responsible for the following:

- Review & approve the equipment listed in the above price for correct quantities of devices.
- Provide CAD files
- Provide parking: minimum 2 vans at no charge. If parking is not available: facility is responsible for all parking fees outside of quoted project.
- Conduit, sleeves & wall penetration per the plans & any additional conduit required for the installation.
- AC power to cabinets & specified locations per plans.
- Emergency/Critical Power as required by code.
- Any state licensing fee and permits.
- Provide & install standard back boxes.
- Install specialty cabinets.
- Responsible for Paint & Patch.
- Provide disposal bin for project trash removal.
- Protection of jobsite.
- Provide server rack.
- Responsible to provide WCTV with rack model.
- Provide network connection within 6ft of rack mounted server.
- Provide VPN Client access to all Nurse Call servers before date of installation.
- If required set up a LAN (Local Area Network) on the hospital's existing backbone.
- Facility is required to send their engineers in for training.
- Ceiling access panels.

- The Customer is responsible for maintaining a suitable climatic condition for the equipment room housing portions of the system. Suitable climatic conditions shall include, but not be limited to, the provision of adequate electrical power, air conditioning and humidity control and other environmental requirements contained in the manufacturer's specifications.

Spare parts are recommended but not included in this quote. A spare parts quote will be issued upon request.

The use of infectious control tents is not included in this quote. Additional Labor charges will apply to use tents.

Scheduled work that is cancelled, refused or if the project is not 100% ready for WC to work a full day when WC arrives is subject to a \$1000.00 charge per occurrence.

West-Call® Manufactured product pricing is good for 90 days, all third party product pricing is not guaranteed. Standard delivery 6 - 8 weeks from receipt of hard copy purchase order. Schedule lead time varies: a minimum 6 week notice is required.

Orders over \$10,000.00 require a 25% down payment, progress billings to be issued, with final billing issued upon completion of installation. Payment terms: net 30 days from invoice date.

THE ABOVE PRICING IS VALID FOR 90-DAYS.

TERMS:

25% Deposit due upon receipt of order. All invoices are Net 30.
A hard copy of the purchase order needs to be issued for project to be scheduled. A 1.5% Finance charge will apply for all late invoices.

Approved By: _____
George Canto

Submitted by: _____
Jonathan Peters, Vice President

P.O. Number: _____